

Copyright © 2000–2020 by Kalkomey Enterprises, LLC. All rights reserved. No part of this Boat Ed® PowerPoint® presentation may be reproduced or copied in any form or by any process without permission in writing from Kalkomey Enterprises, LLC.

BOAT **RHODE ISLAND**

A Course on Responsible Boating

Sponsored by



Class Plan

- ◆ **Lesson One:** Know Your Boat
- ◆ **Lesson Two:** Before You Get Underway
- ◆ **Lesson Three:** Operating Your Boat...Safely
- ◆ **Lesson Four:** Legal Requirements of Boating
- ◆ **Lesson Five:** Boating Emergencies...What to Do
- ◆ **Lesson Six:** Enjoying Water Sports With Your Boat

Lesson One



Know Your Boat

Key Topics

- ◆ **Parts of a Boat**
- ◆ **Types of Boat Hulls**
- ◆ **Length of a Vessel**
- ◆ **Types of Engines and Drives**
- ◆ **Personal Watercraft**
- ◆ **Sailboats**

Objectives

You should be able to...

- ◆ Identify the basic parts of a boat, a personal watercraft, and a sailboat.
- ◆ Identify the different types of hulls and their performance characteristics.
- ◆ Identify the different kinds of engines commonly found in recreational vessels.

The Many Parts of a Boat

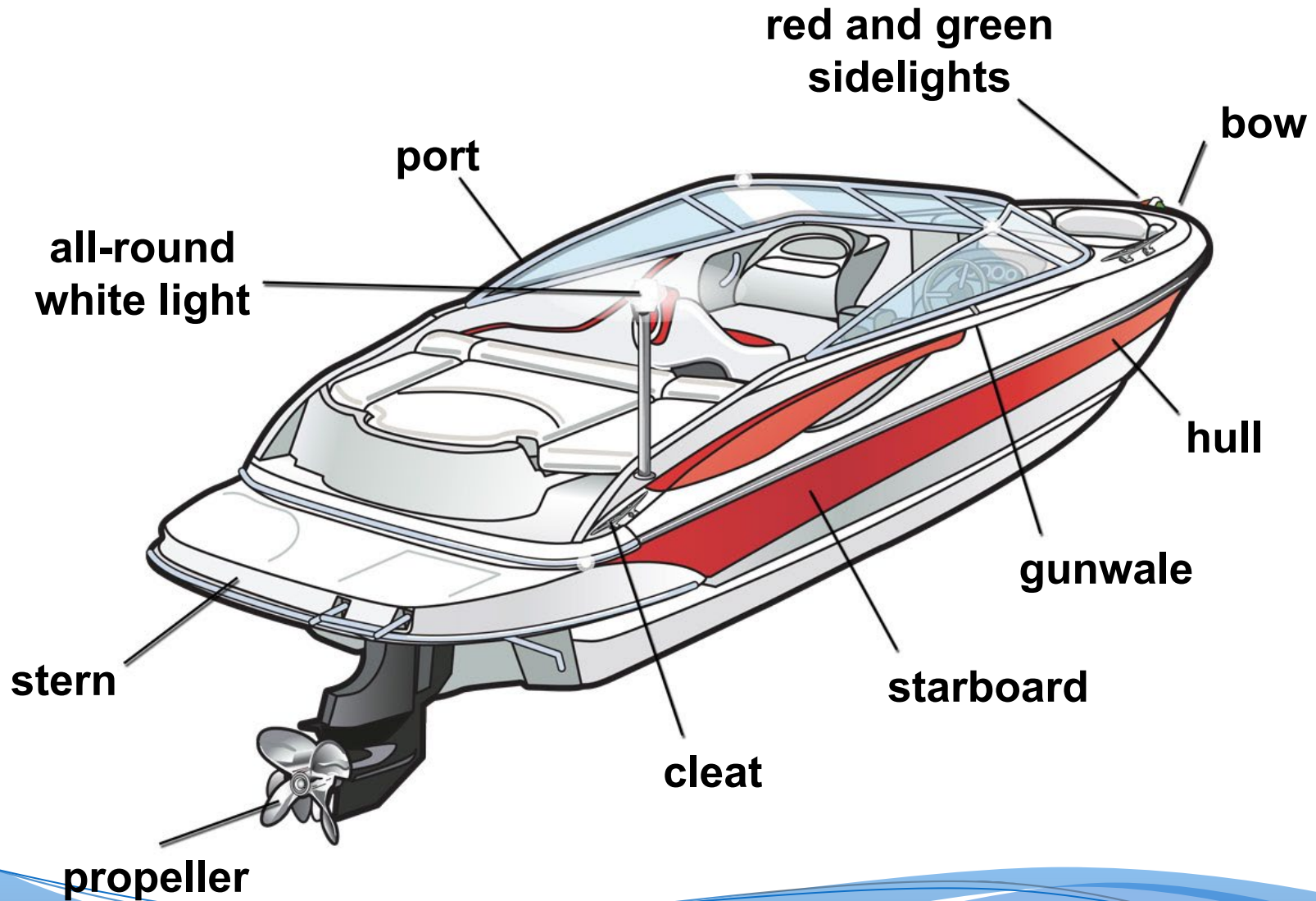

The Many Parts of a Boat

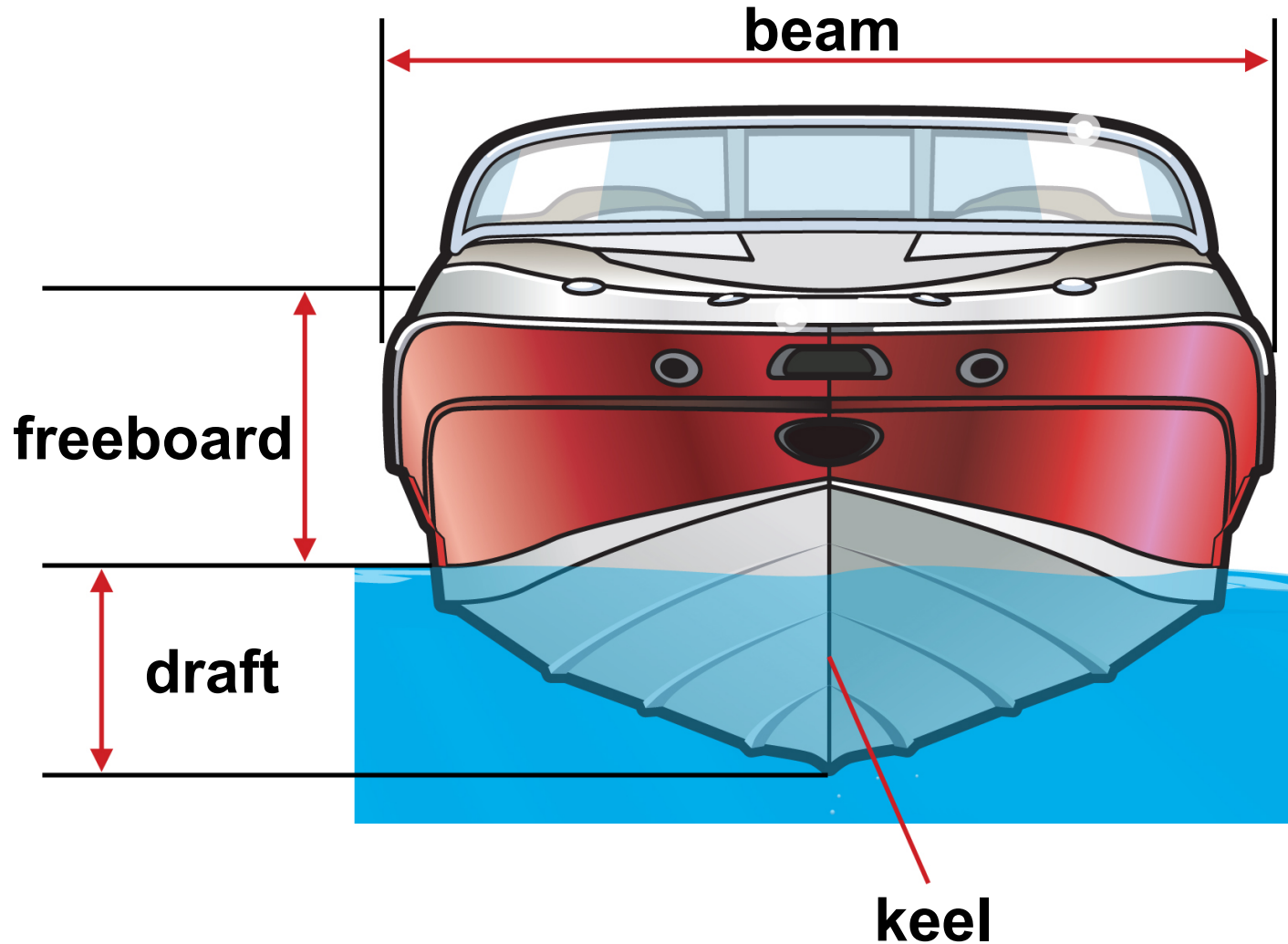

Types of Boat Hulls

Displacement Hulls

◆ Round-Bottomed Hull

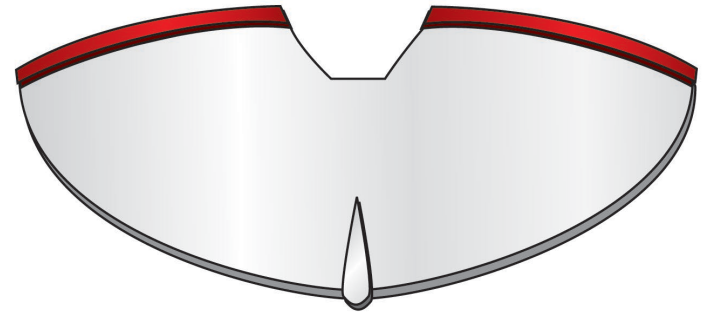

Round Bottom

Types of Boat Hulls

Planing Hulls

◆ Flat-Bottomed Hull

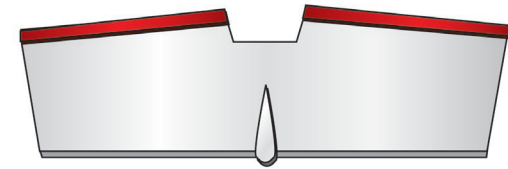

Flat Bottom

◆ Vee-Bottomed Hull

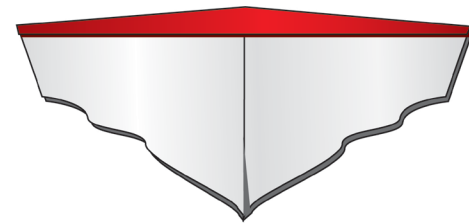

Vee Bottom

Types of Boat Hulls

How Planing Hulls Operate

◆ Displacement Mode

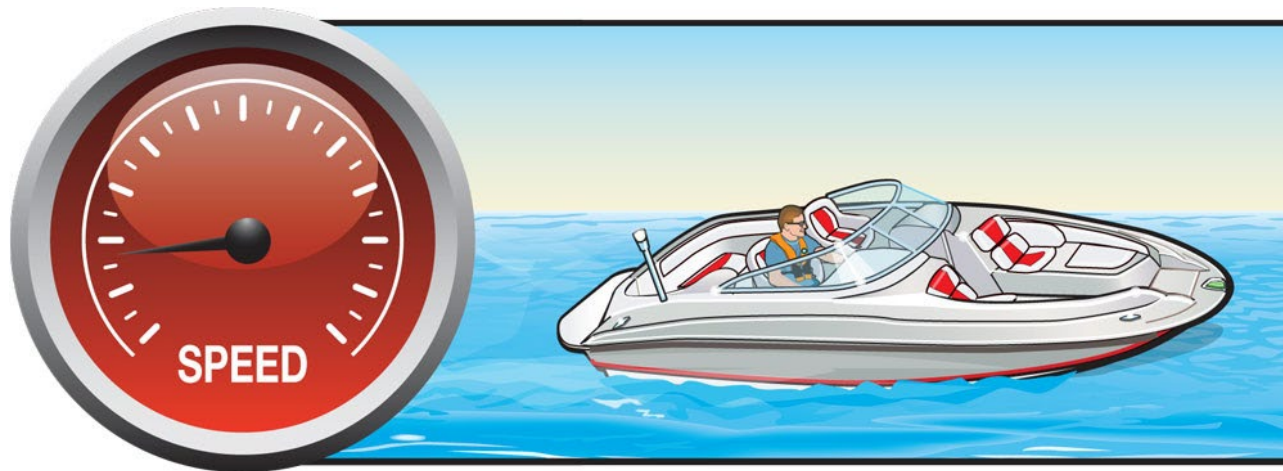

Types of Boat Hulls

◆ Plowing Mode

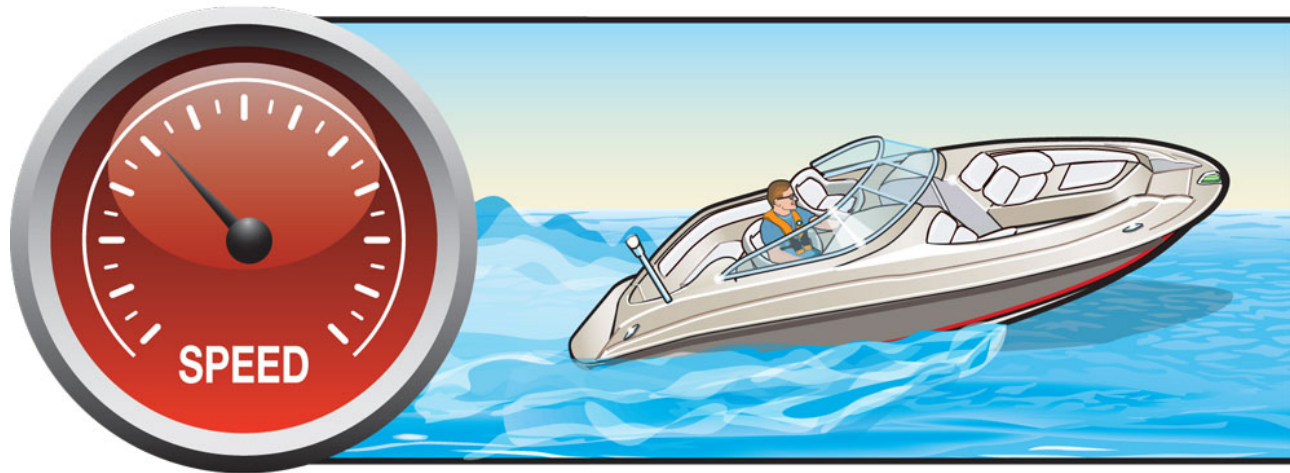

Types of Boat Hulls

◆ Planing Mode

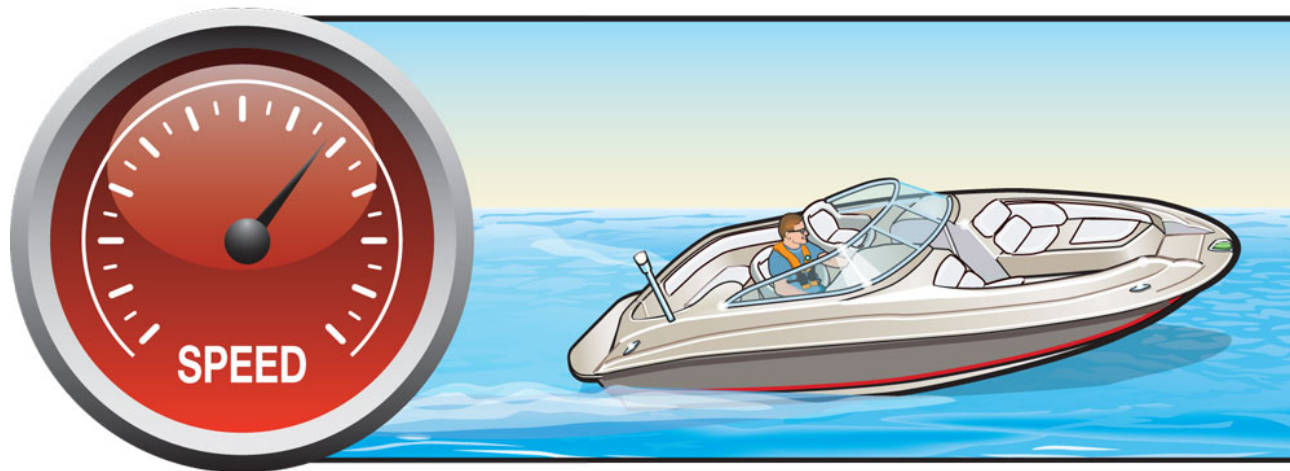



Length of a Vessel

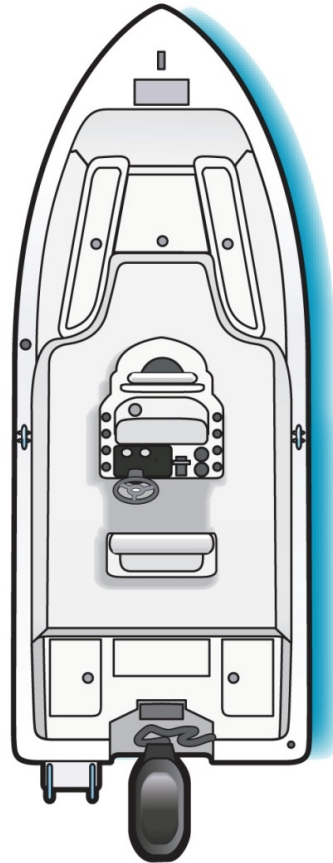



Length of a Vessel

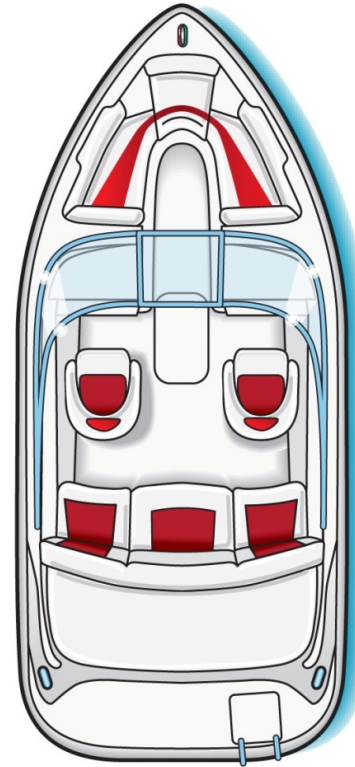

Length of a Vessel

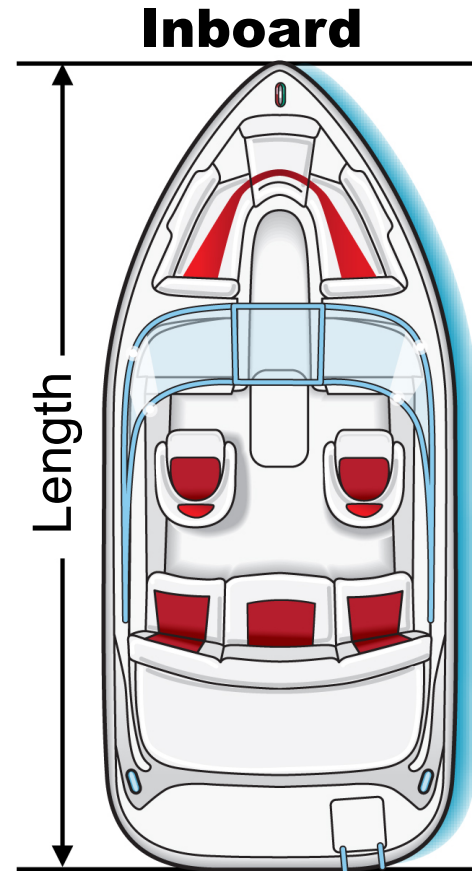
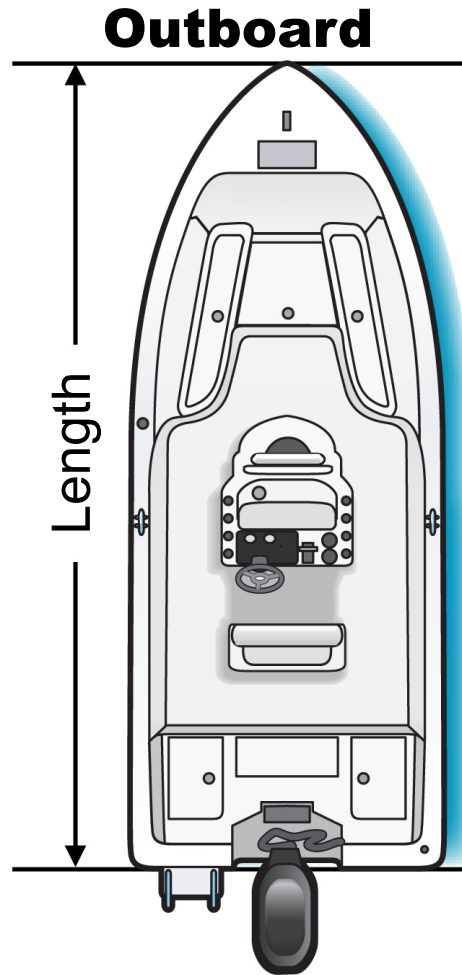

Length of a Vessel

- ◆ Less than 16 feet (Class A)
- ◆ 16 feet to less than 26 feet (Class 1)
- ◆ 26 feet to less than 40 feet (Class 2)
- ◆ 40 feet to less than 65 feet (Class 3)

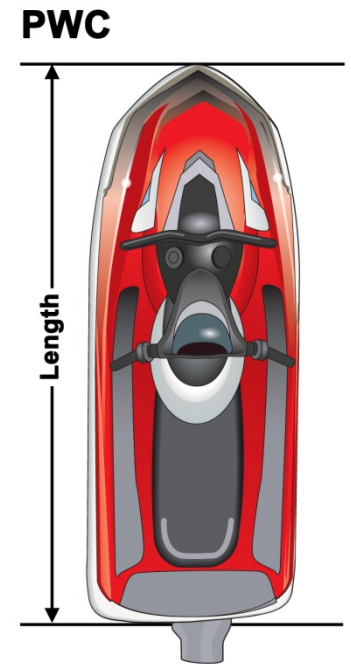

Types of Engines and Drives

Outboards

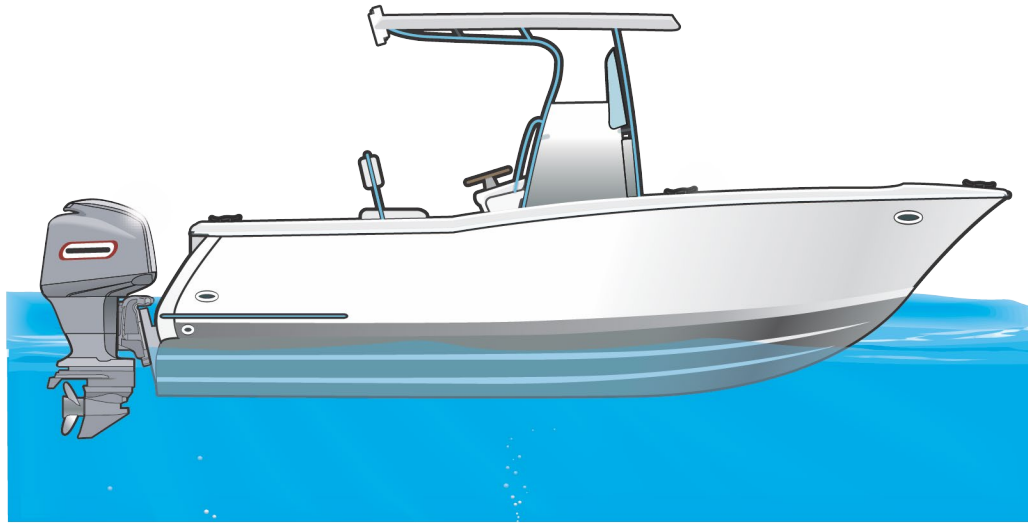

Types of Engines and Drives

Inboards

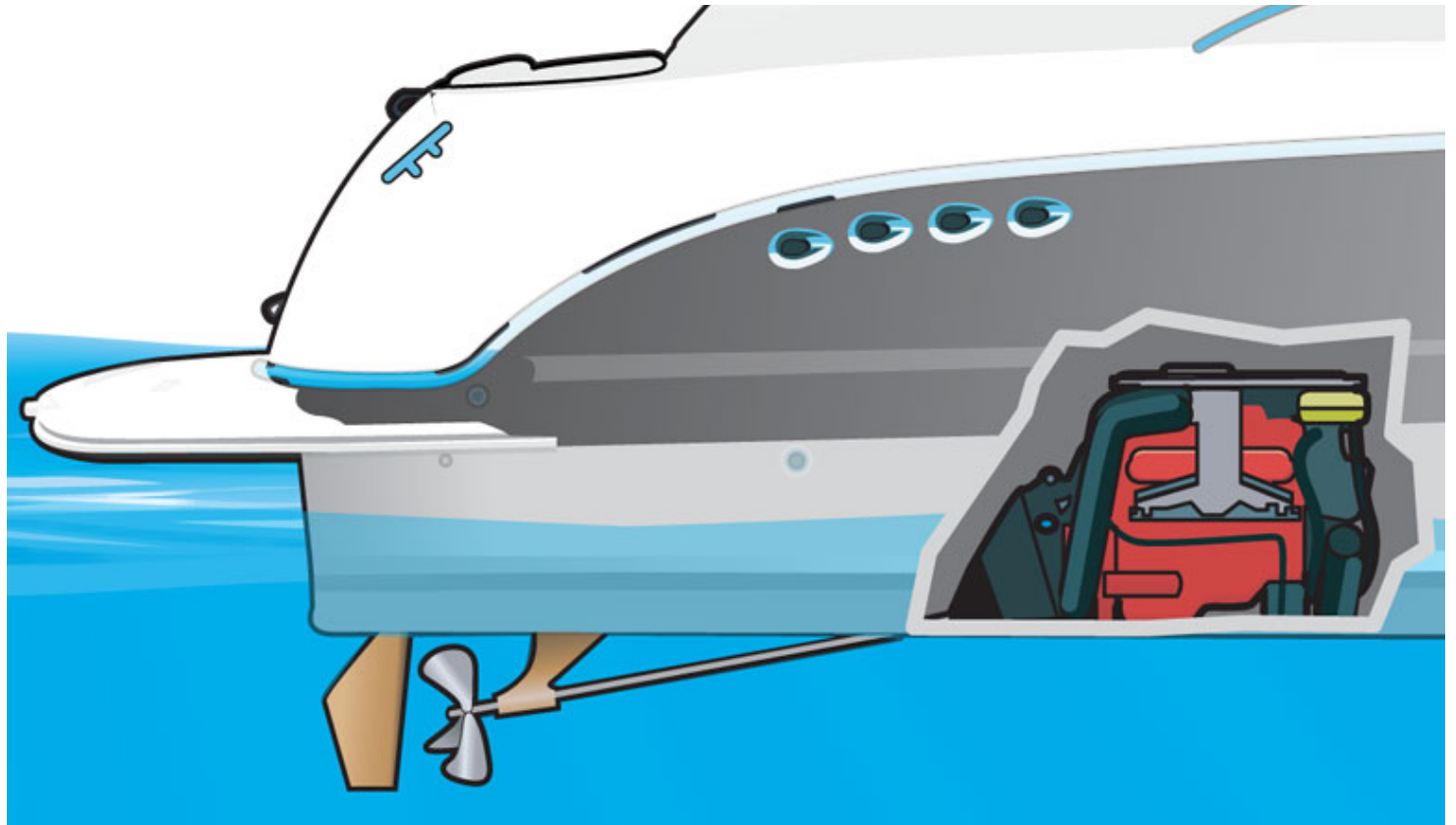

Types of Engines and Drives

Stern Drives

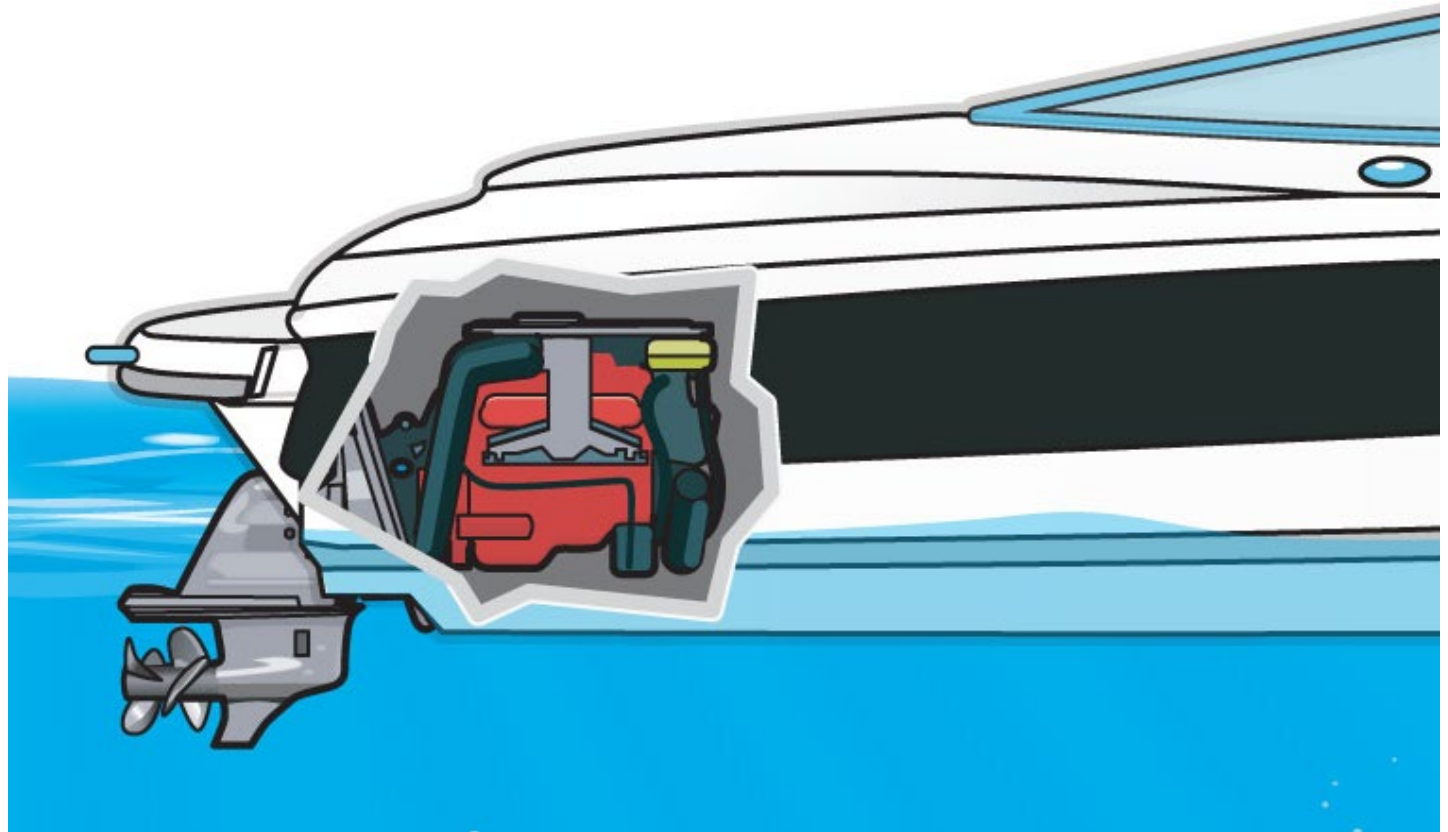

Types of Engines and Drives

Jet Drives

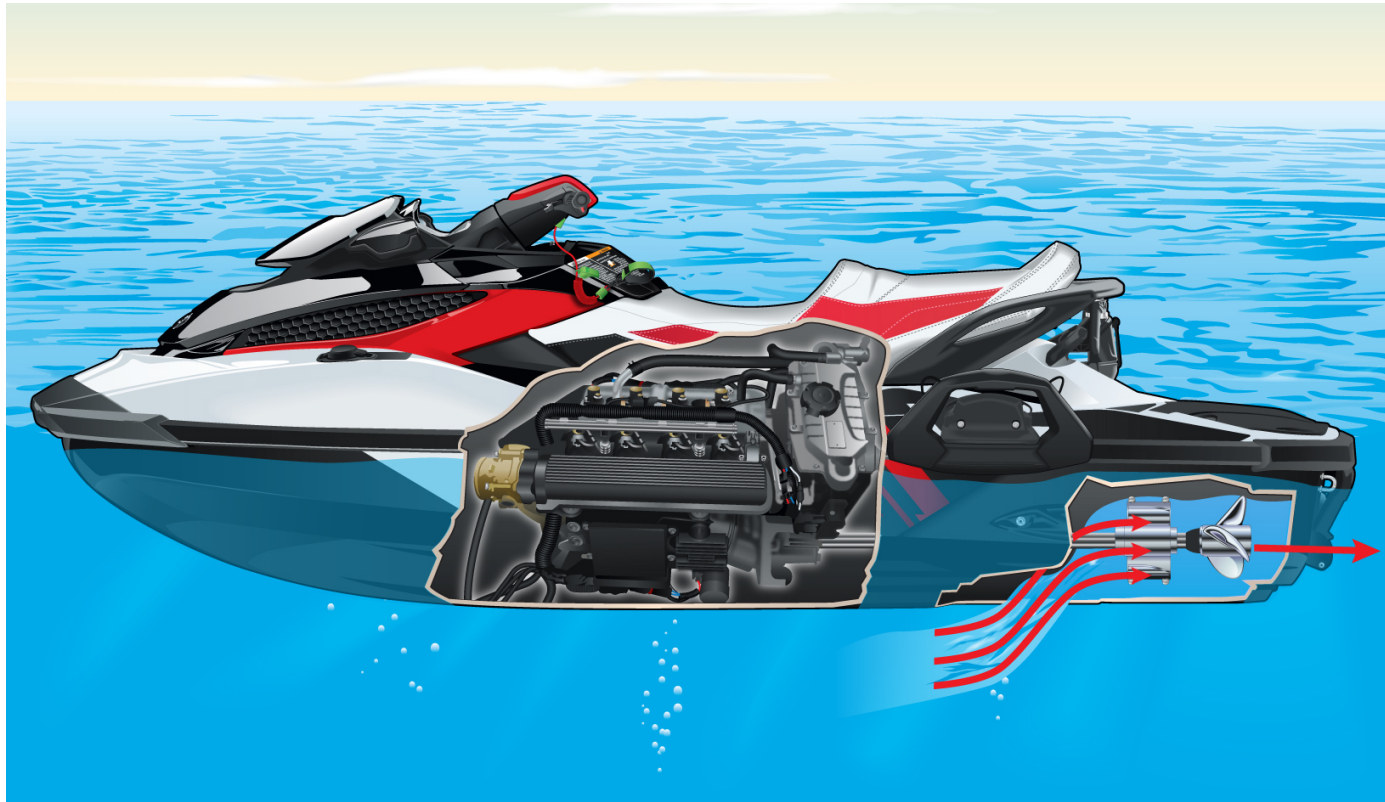

Types of Engines and Drives

Jet Drives

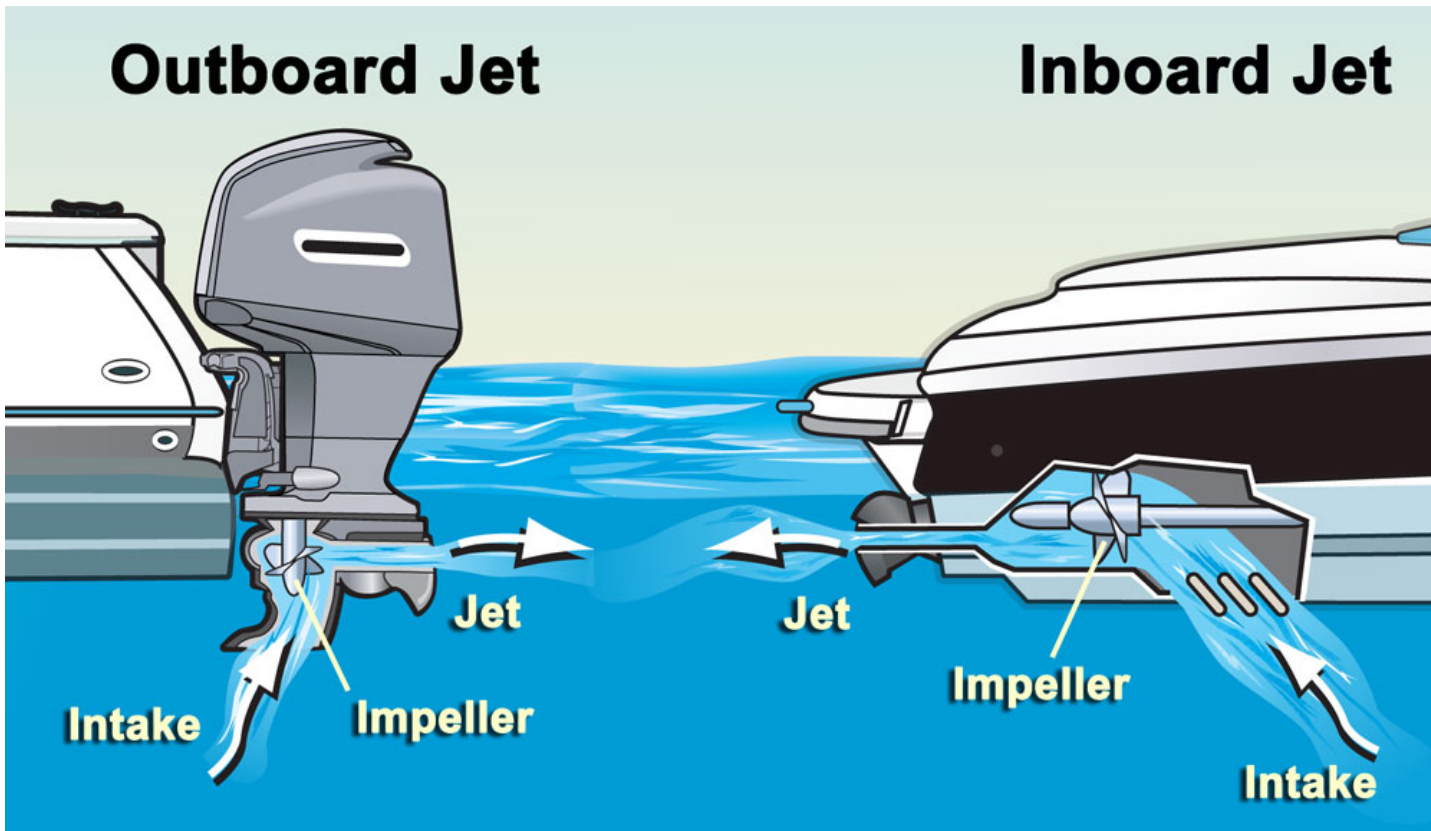

Personal Watercraft

- ◆ **Jet-propelled watercraft come in many sizes. The personal watercraft (PWC) is the most common for recreational boaters.**
- ◆ **PWC:**
 - **Use an inboard jet drive as primary source of propulsion.**
 - **Are included in the group of inboard vessels less than 16 feet in length.**
 - **Are subject to the same laws and requirements of any other vessel plus some specific to PWC.**

Personal Watercraft



Personal Watercraft



Sailboats

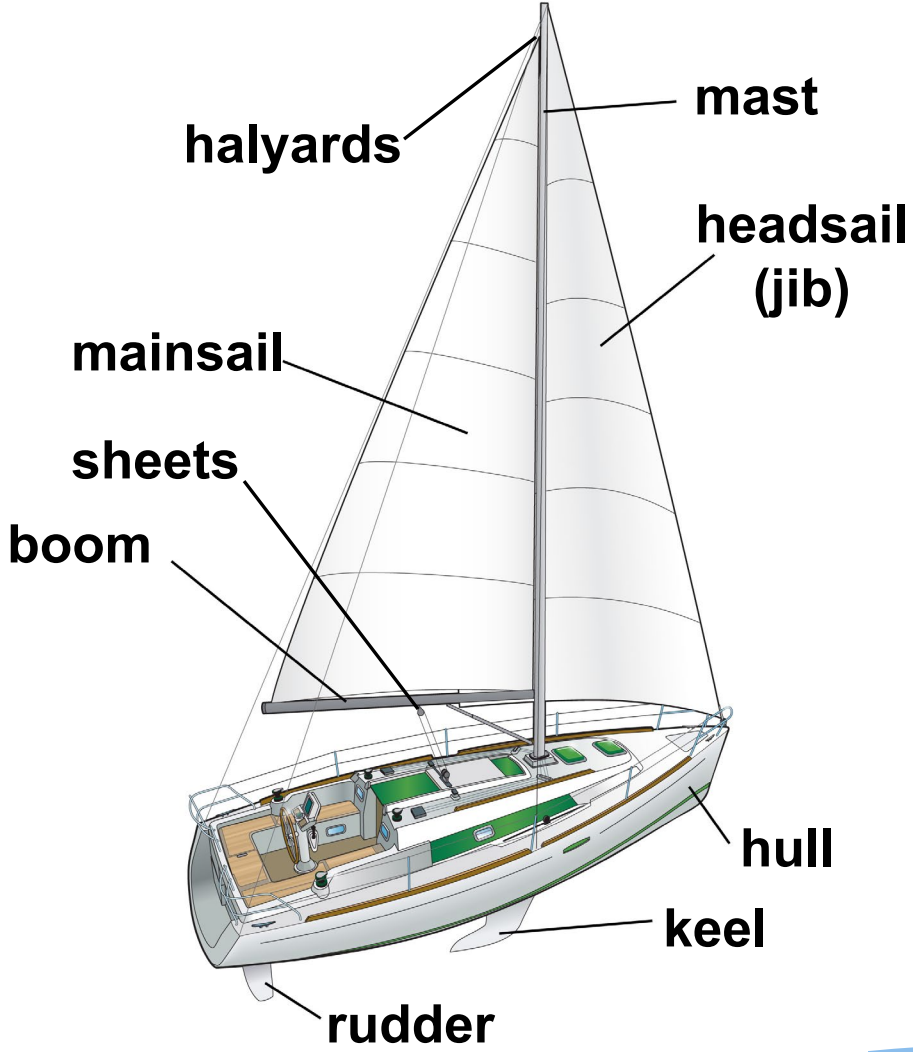

Lesson Two

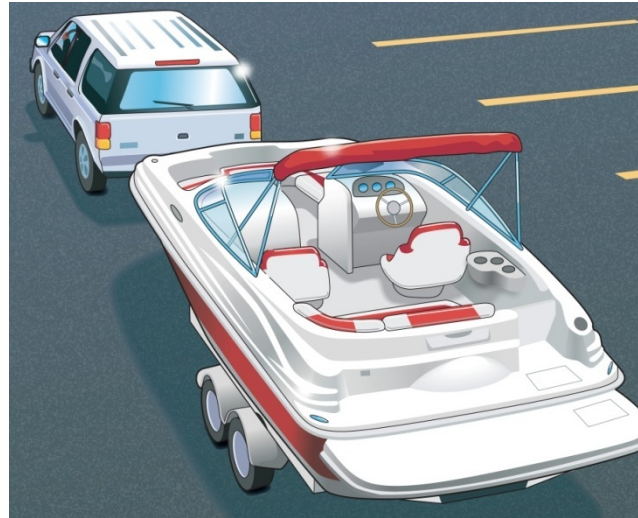

Before You Get Underway

Key Topics

- ◆ **Boat's Capacity**
- ◆ **Float Plans**
- ◆ **Fueling a Vessel and a Personal Watercraft**
- ◆ **Trailer/Courtesy on the Boat Ramp**
- ◆ **Vessel and Engine Maintenance**

Objectives

You should be able to...

- ◆ **Locate and understand a boat's capacity plate.**
- ◆ **File a proper float plan.**
- ◆ **Explain how to fuel a vessel safely.**
- ◆ **Explain how to launch a vessel from a trailer and retrieve it from the water safely and courteously.**
- ◆ **Give the basics of vessel and engine maintenance.**

Boat Capacity

- ◆ **Maximum weight includes weight of:**
 - **Passengers**
 - **Gear**
 - **Motors**

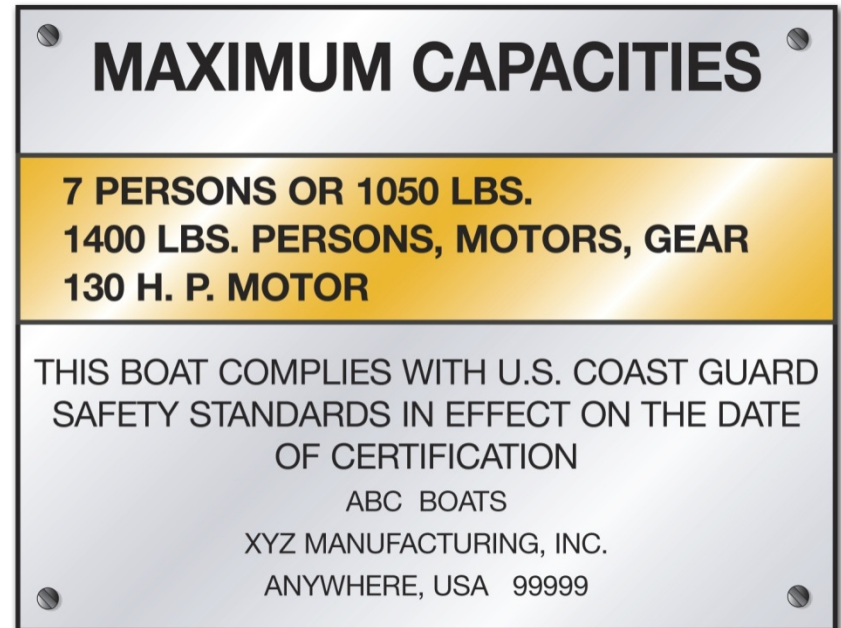

Boat Capacity

- ◆ Do not exceed the recommended capacity found in the owner's manual and on manufacturer's warning decal.
- ◆ On outboard boats, never exceed the maximum horsepower rating shown on the capacity plate.
- ◆ On vessels less than 20 feet in length without a capacity plate:

$$\text{Number of people} = \frac{\text{vessel length (ft.)} \times \text{vessel width (ft.)}}{15}$$

Boat Capacity

Example:

Vessel Length: 18 feet

Vessel Width: 6 feet

Number of people = $\frac{18 \text{ feet long} \times 6 \text{ feet wide}}{15}$

Number of people = $\frac{108}{15}$

Number of people = 7.2
(no more than 7 people on board)

File a Float Plan

- ◆ For short outings, inform a responsible person of:
 - **WHERE** you are boating
 - **WHEN** you are returning
 - **WHO** to call



File a Float Plan

- ◆ For extended outings, include:
 - WHO is going
 - WHERE you are going
 - WHAT boat you are in
 - WHEN you are leaving and returning

Fuel Your Vessel...Safely

◆ Before fueling:

- Refuel away from the water.
- Tie up the boat.
- Unload all passengers.
- Turn off all sources that could result in a flame.
- Close all windows, ports, and doors.
- Unload portable fuel tanks.

Fuel Your Vessel...Safely

◆ While filling the fuel tank:

- **Keep nozzle of fuel-pump hose in contact with tank opening.**
- **Use caution and fill tank slowly.**
- **Never fill tank to brim.**
- **Wipe up any spilled fuel.**

Fuel Your Vessel...Safely

◆ After fueling:

- Put fill cap on tightly.
- Open all windows, ports, doors, and other openings.
- Turn on exhaust blower for four minutes.
- Sniff for fuel vapors.
- Start engine and reload passengers.

Fuel Your Vessel...Safely

- ◆ To make sure you do not run out of fuel, use this rule:
 - One-third to get out
 - One-third to get back
 - One-third in reserve

Fuel Your Vessel...Safely

Fueling Issues for a Personal Watercraft (PWC)

- ◆ Check fuel system for leaks and inspect connections frequently.
- ◆ Avoid fuel spills in or near water.
- ◆ **Do not tip PWC to fill all the way up.**
- ◆ After fueling, sniff to check for gas fumes.

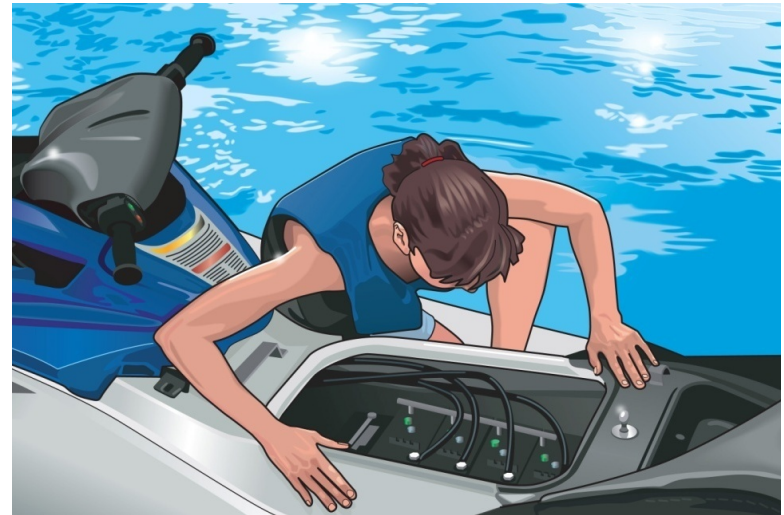

Fuel Selector Switch on a PWC

- ◆ OFF
- ◆ ON
- ◆ RESERVE

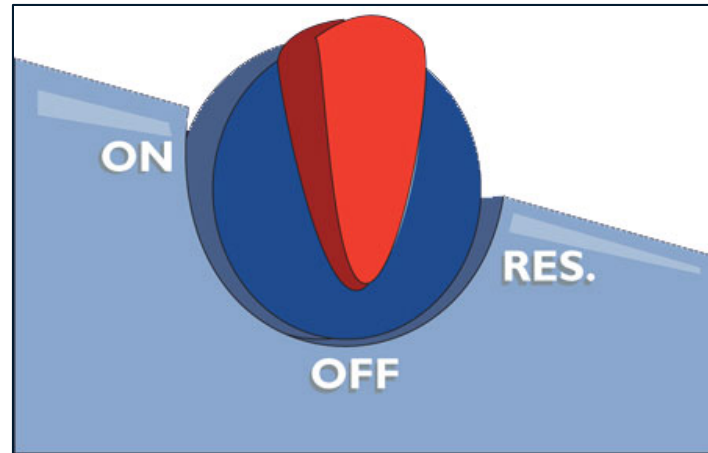

Trailer Your Vessel

Choose the Right Trailer & Vehicle to Tow Your Vessel

- ◆ **The trailer and towing vehicle should be designed to fit your vessel.**
 - **Use the size of vessel to determine the trailer's dimensions.**

Trailer Your Vessel

- **Make sure the weight of the vessel and engine does not exceed 90% of trailer's load capacity. The trailer must carry your:**
 - **Vessel**
 - **Engine**
 - **Fuel**
 - **Gear**



Trailer your Vessel

Example:

Vessel Size: 19 feet long

Weight of Vessel: 2600 lbs. (Includes weight of engine, fuel, and gear)

Which capacity trailer would you choose?



2300 lbs.

OR

3000 lbs.

Trailerding Your Vessel

Choosing the Right Vehicle

◆ The towing vehicle must be rated to tow the combined weight of:

- Vessel
- Engine
- Trailer

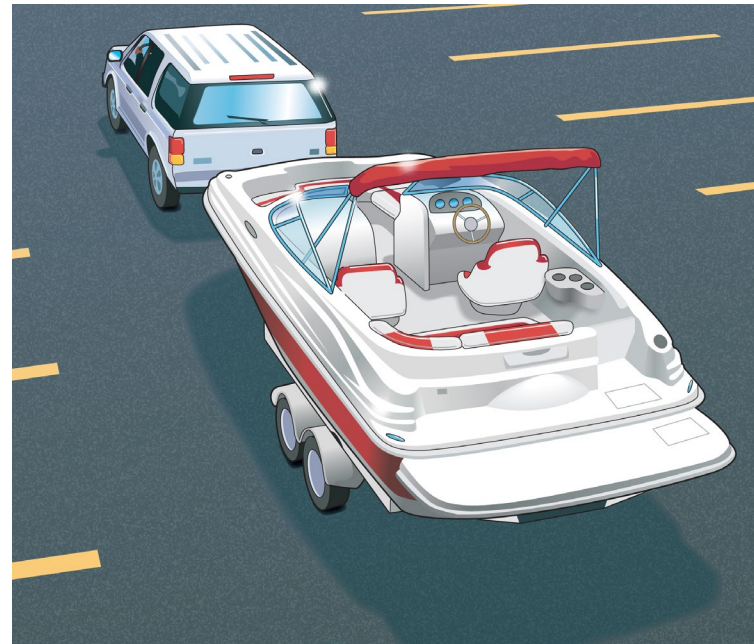

Trailer Your Vessel

- ◆ Towing hitch must be appropriate for the loaded trailer.
 - Ball hitch
 - Coupler
 - Tongue weight

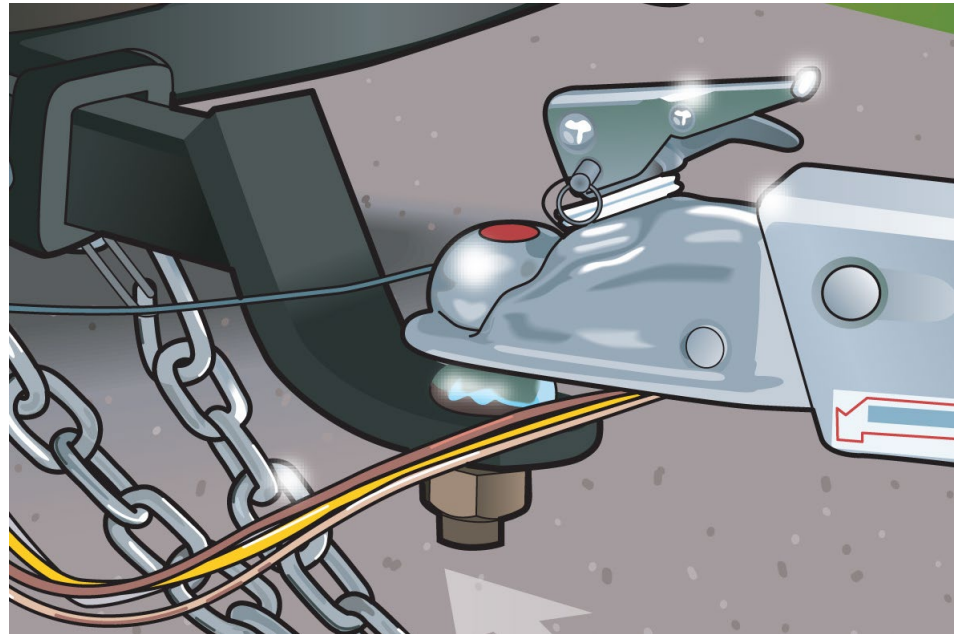

Trailer Your Vessel

Example:

The trailer for the vessel has a $2 \frac{5}{16}$ " coupler.

Which of the following sizes of ball hitch must be used on the towing vehicle?



$2 \frac{1}{4}$ "

$2 \frac{1}{2}$ "

$2 \frac{5}{16}$ "

$2 \frac{3}{8}$ "

Trailerding Your Vessel

Before leaving home:

- ◆ Secure all gear in the vessel.
- ◆ Secure the vessel to the trailer.
- ◆ Secure engine.
- ◆ Crisscross two safety chains under the trailer tongue.

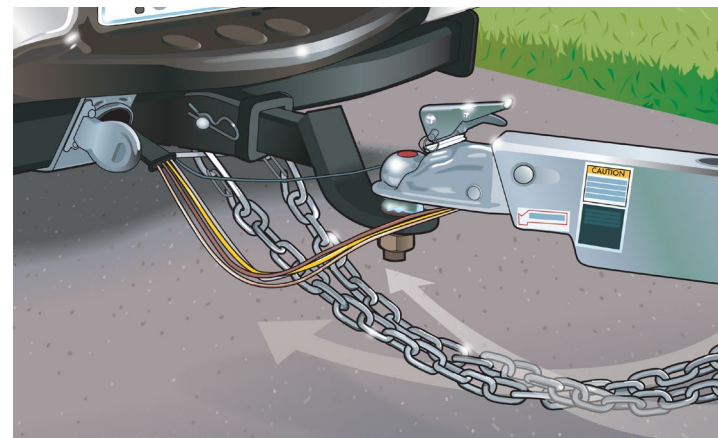

Trailer Your Vessel

- ◆ **Inspect and maintain trailering equipment.**
 - **Check tire pressure on all tires.**
 - **Tighten lug nuts.**
 - **Grease wheel bearings.**
 - **Check lights and brakes.**
 - **Check tie-down straps, lines, winch, safety chains, and hitch.**



Trailer Your Vessel

On the Road With a Trailer

- ◆ **Drive cautiously.**
 - Drive at moderate speeds.
 - On long trips, pull over every hour or so to check vehicle, trailer, and gear.
- ◆ **Allow for added length and weight of trailer.**
 - Make wider turns at corners and curves.
 - Allow extra time and distance to stop and pass.

Trailer Your Vessel

Launching Your Vessel From a Trailer

- ◆ **Don't block ramp traffic!**
 - **Transfer all gear to the vessel.**
 - **Disconnect trailer lights.**
 - **Leave the winch line secured to the vessel.**
 - **Remove tie-down straps.**
 - **Ensure drain plug is in place.**
 - **Tie a rope to the vessel's bow.**



Trailer Your Vessel

- ◆ **Back the trailer into the water.**
 - **Set the parking brake on the towing vehicle.**
 - **Lower the vessel's engine or outdrive.**
 - **Start the engine.**
 - **Back the trailer into the water until the vessel floats.**
 - **Undo the winch line. Back the vessel off the trailer.**

Trailerding Your Vessel

Retrieving Your Vessel

- ◆ Wait for your turn.
- ◆ Back the trailer into the water.
 - Set parking brake.
 - Attach winch line.
 - Shut off engine.
 - Raise engine or outdrive.
 - Pull trailer out of the water.



Trailerding Your Vessel

- ◆ Do not power load your boat. Propeller wash can create:
 - A large hole where trailer tires can get stuck
 - A mound where boats can run aground

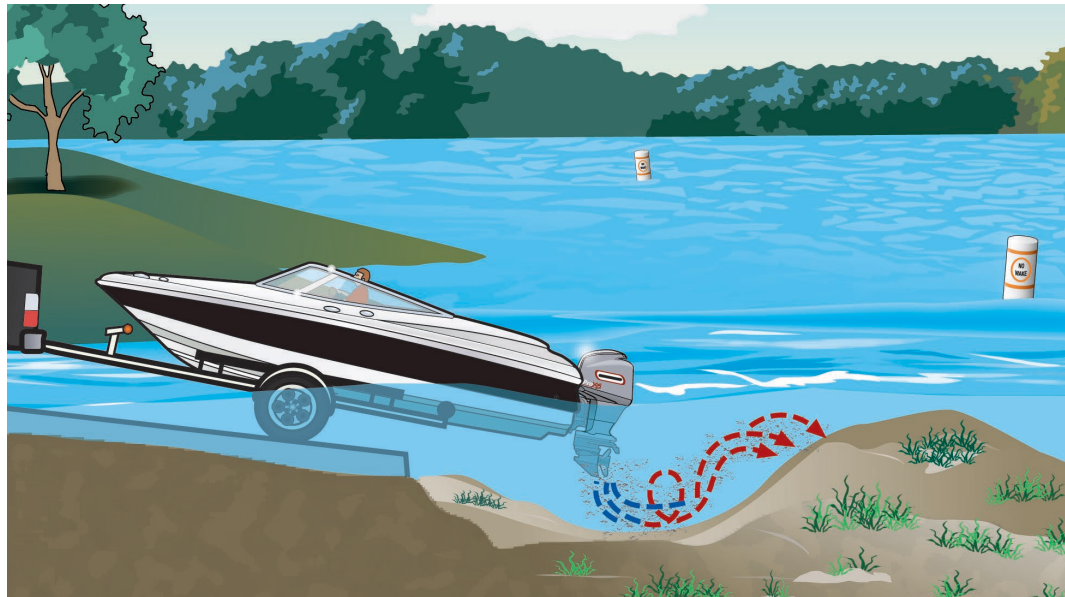

Trailerding Your Vessel

- ◆ Prepare for drive home well away from boat ramp.
 - Do not block ramp traffic.
 - Remove and dispose of all aquatic nuisance species.
 - Remove the drain plug.
 - Secure your vessel and gear.



Trailer Your Vessel

Courtesy on the Boat Ramp

- ◆ **Prepare your vessel for launching well away from the ramp.**
- ◆ **Use at least two experienced people to launch and retrieve.**
- ◆ **Never block ramp with unattended vessel or vehicle.**

Trailer Your Vessel

- ◆ **When retrieving, do not pull vessel into launch lane until towing vehicle is at ramp.**
- ◆ **After retrieving your vessel, pull well away from ramp before preparing for the drive home.**

Vessel Maintenance

- ◆ **Examine the hull when it is out of the water.**
- ◆ **Store vessels in a dry area out of the sun.**
- ◆ **Clean all lines, and keep them out of the sun.**
- ◆ **Clean sails, and make repairs.**
- ◆ **Follow the maintenance schedule in the owner's manual.**

Engine Maintenance

Follow a regular maintenance program.

- ✓ **Keep engine clean and tuned properly.**
- ✓ **Check oil and fluid levels before every outing.**
- ✓ **Tighten battery connections. Clean battery terminals.**
- ✓ **Inspect hoses, belts, and bolts.**
- ✓ **Never use automotive electrical parts.**

Preventing Theft

- ◆ **Store vessel so it is not easily accessed.**
- ◆ **Chain and lock motor and fuel tanks to vessel.**
- ◆ **Mark or engrave all equipment.**
- ◆ **Photograph or videotape interior and exterior of vessel. Make a complete inventory.**
- ◆ **Remove all valuables.**
- ◆ **Cover vessel and remove keys.**

Lesson Three



Operating Your Boat...Safely

Key Topics

- ◆ **Casting Off and Docking**
- ◆ **Navigation Rules**
- ◆ **Navigation Lights**
- ◆ **Night Navigation**
- ◆ **Sound Signals**
- ◆ **Navigational Aids**

Key Topics

- ◆ **Anchoring**
- ◆ **Dams, Locks, and Bridges**
- ◆ **Changing Water Levels**
- ◆ **Compasses and Charts**
- ◆ **Jet-Propelled Watercraft Operation**
- ◆ **Engine Cut-Off Switches**
- ◆ **Avoiding Propeller Strike Injuries**

Objectives

You should be able to...

- ◆ **Cast off and dock under different wind and current conditions.**
- ◆ **Give three major responsibilities of a vessel operator.**
- ◆ **Explain what to do when encountering another vessel.**
- ◆ **List the types of nighttime navigation lights and explain how to interpret them.**

Objectives

- ◆ **Use and understand sound signals.**
- ◆ **Explain what to do when encountering buoys and markers of the U.S. Aids to Navigation System.**
- ◆ **Anchor a vessel correctly.**
- ◆ **Explain what to do when encountering various hazards—dams, locks, bridges, and changing water levels.**

Objectives

- ◆ **Explain how to use a compass and read a nautical chart.**
- ◆ **Operate a personal watercraft safely and courteously.**
- ◆ **Explain how an engine cut-off switch works.**
- ◆ **Explain how to avoid propeller strike injuries.**

Casting Off

◆ Before casting off:

- **Keep the boat tied to dock while the engine warms up.**
- **Make sure everyone is seated and wearing a personal flotation device (PFD).**
- **Check that the engine is running properly and the area is clear of traffic.**

Casting Off

- ◆ **If there is no wind or current:**
 - **Cast off the bow and stern lines.**
 - **Shift into forward gear.**
 - **Slowly move forward, gradually turning the boat away from the dock.**

Casting Off

- ◆ **If the wind or current direction is toward the dock:**
 - **Cast off the stern line. Move and secure the bow line to a mid-boat position on the dock. Make sure fenders are in place on the bow.**
 - **Put the boat into forward gear briefly, and turn the steering wheel hard toward the dock. Increase speed slowly until the stern is well clear of the dock.**
 - **Cast off the bow line. Back out slowly until you have room to shift into forward and turn away from the dock.**

Casting Off

- ◆ **If the wind or current direction is away from the dock:**
 - **Cast off the bow and stern lines.**
 - **Use an oar or boat hook to keep the boat clear of the dock. Let the wind or current carry the boat away from the dock.**
 - **Once there is sufficient clearance, shift into forward gear and slowly leave the area.**

Docking

- ◆ **As you approach the dock:**
 - **Slow down.**
 - **Wait for traffic to clear.**
 - **Get bow and stern lines ready.**
 - **Head into the wind or current—whichever is stronger.**
 - **Put boat fenders in place.**

Docking

◆ If there is no wind or current:

- Approach the dock slowly at a narrow angle (about 20 degrees).
- When close enough, have a passenger step on shore and secure the bow line.
- Swing the stern in with a line or boat hook, and secure it.

Docking

- ◆ **If the wind or current direction is toward the dock:**
 - **Approach slowly, parallel to the dock.**
 - **Let the wind or current carry your boat to the dock. Shift into gear briefly if you need to adjust position.**
 - **Secure the bow and stern lines.**

Docking

- ◆ **If the wind or current direction is away from the dock:**
 - **Approach the dock slowly at a sharp angle (about 40 degrees).**
 - **Use reverse to stop when close to the dock. Secure the bow line.**
 - **Put the boat in forward gear briefly, and slowly turn the steering wheel hard away from the dock—this will swing in the stern. Secure the stern line.**

Navigation Rules

Three basic rules of navigation:

- ◆ Practice good seamanship.
- ◆ Keep a proper lookout.
- ◆ Maintain a safe speed.

Navigation Rules

- ◆ Two terms help explain what to do when encountering other vessels.



Give-Way Vessel

Stand-On Vessel

Navigation Rules

- ◆ **The action a vessel operator should take when encountering another vessel depends on:**
 - **How the two vessels are propelled**
 - **How the two vessels are approaching one another**

Navigation Rules

Rules of Responsibility

- ◆ **All boaters are responsible for preventing collisions.**
- ◆ **If you must make a departure from the navigation rules, make this decision based on:**
 - **All the dangers of navigation**
 - **The risk of a collision**
 - **Any special conditions**

Navigation Rules

◆ Always give way to:

- Anchored or disabled vessels
- Vessels restricted in their ability to maneuver
- Vessels constrained by their draft
- Commercial fishing vessels

Navigation Rules

Navigation During Restricted Visibility

- ◆ **Keep a safe speed for the conditions.**
- ◆ **Slow down to avoid a collision.**
- ◆ **Reduce speed to idle speed if necessary.**

Navigation Rules

Power-Driven Vessel Encountering Power-Driven Vessel—Meeting Head-On

Neither vessel is the stand-on vessel. Both vessels should turn to starboard (the right).

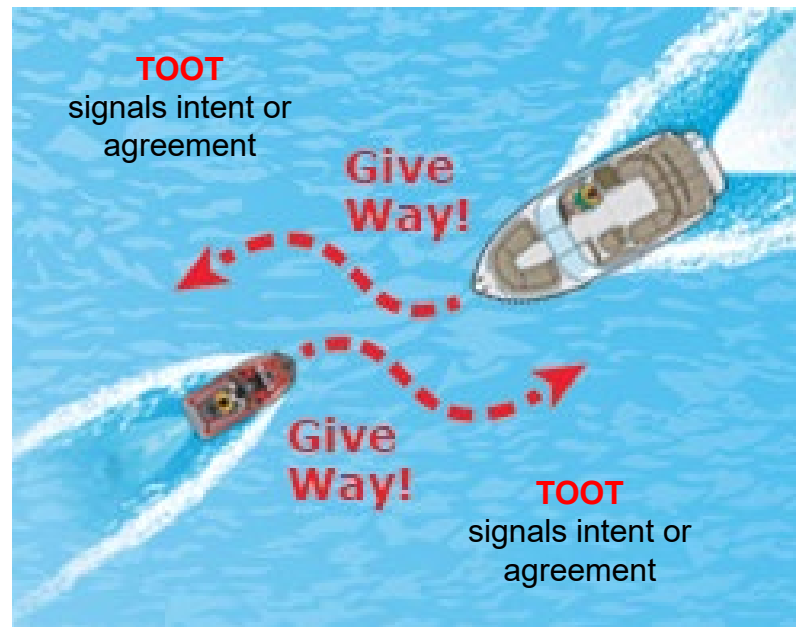

Navigation Rules

Power-Driven Vessel Encountering Power-Driven Vessel—Paths That Cross

The vessel on the operator's port (left) is the give-way vessel. The vessel on the operator's starboard (right) is the stand-on vessel.

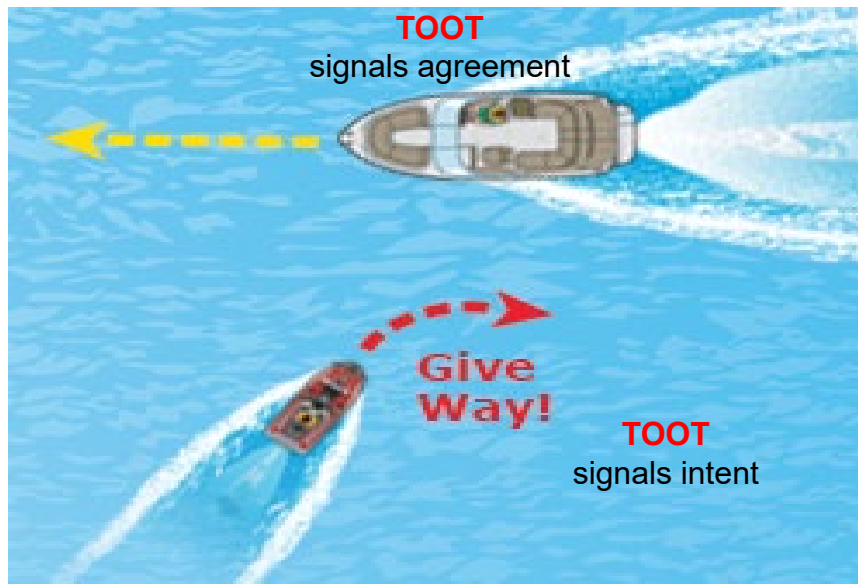

Navigation Rules

Power-Driven Vessel Overtaking a Power-Driven Vessel

The vessel that is overtaking another vessel is the give-way vessel. The vessel being overtaken is the stand-on vessel.

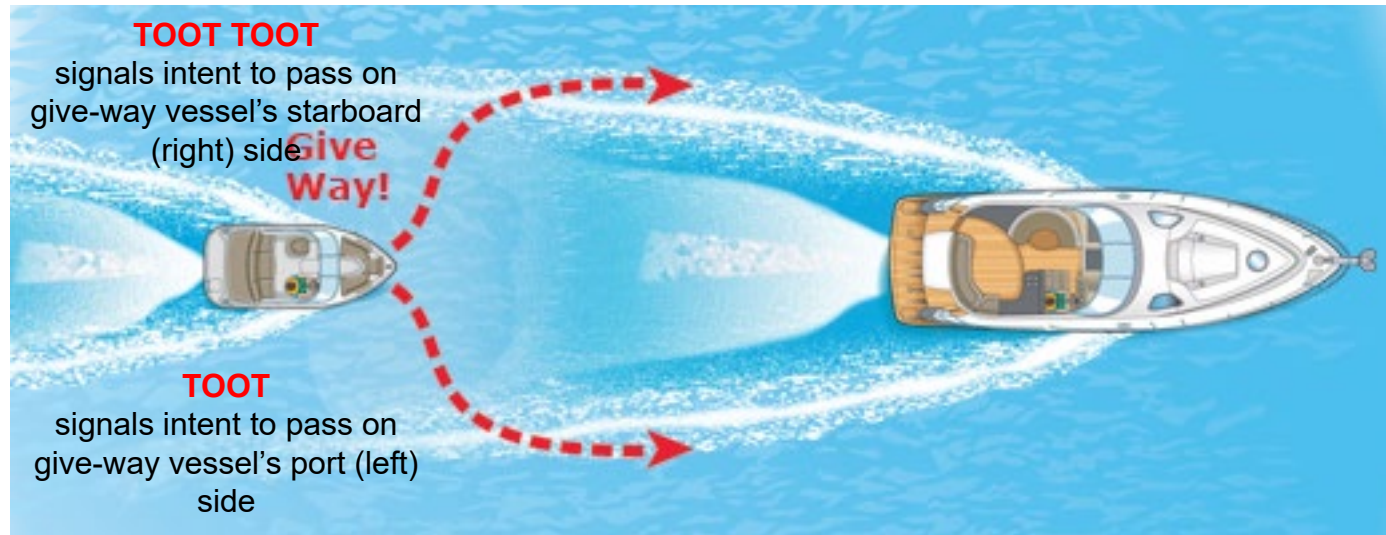

Navigation Rules

Sailing Vessel Encountering Sailing Vessel—Wind on Same Side

When two sailing vessels are approaching one another with the wind on the same side, the leeward sailing vessel is the stand-on vessel.



Navigation Rules

Sailing Vessel Encountering Sailing Vessel—Wind on Different Sides

When two sailing vessels are approaching one another with the wind on the different sides, the sailing vessel with wind on its starboard (right) side is the stand-on vessel.

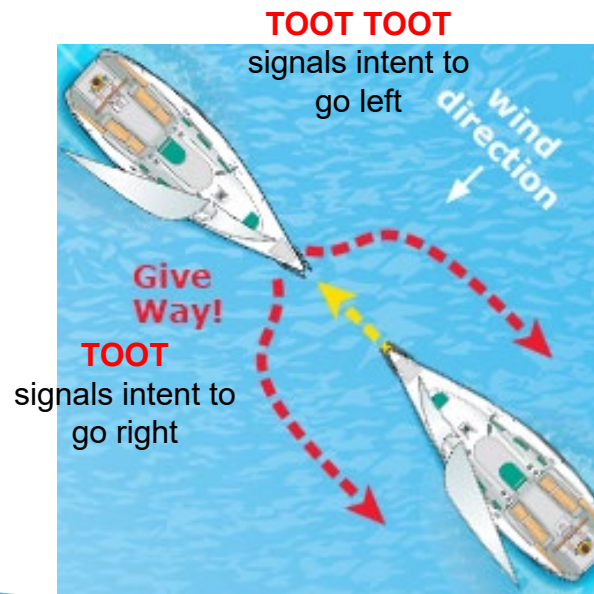

Navigation Rules

Power-Driven Vessel Encountering Sailing Vessel— Meeting Head-On

The power-driven vessel is the give-way vessel. The sailing vessel is the stand-on vessel.

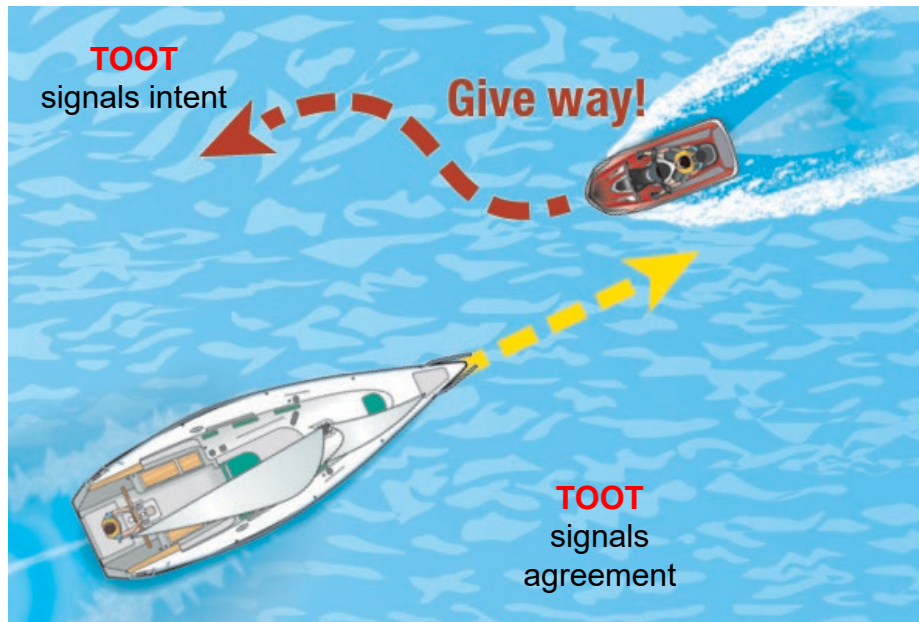

Navigation Rules

Power-Driven Vessel Encountering Sailing Vessel— Paths That Cross

The power-driven vessel is the give-way vessel. The sailing vessel is the stand-on vessel.



Navigation Rules

Power-Driven Vessel Overtaking a Sailing Vessel or Vice Versa

The vessel that is overtaking another vessel is the give-way vessel, regardless of whether it is a sailing vessel or a power-driven vessel. The vessel being overtaken is always the stand-on vessel.

Power-Driven Vessel Overtaking a Sailing Vessel



TOOT TOOT
signals intent to
pass on the give-
way vessel's
starboard (right)
side

TOOT TOOT
signals intent to
pass on the give-
way vessel's port
(left) side

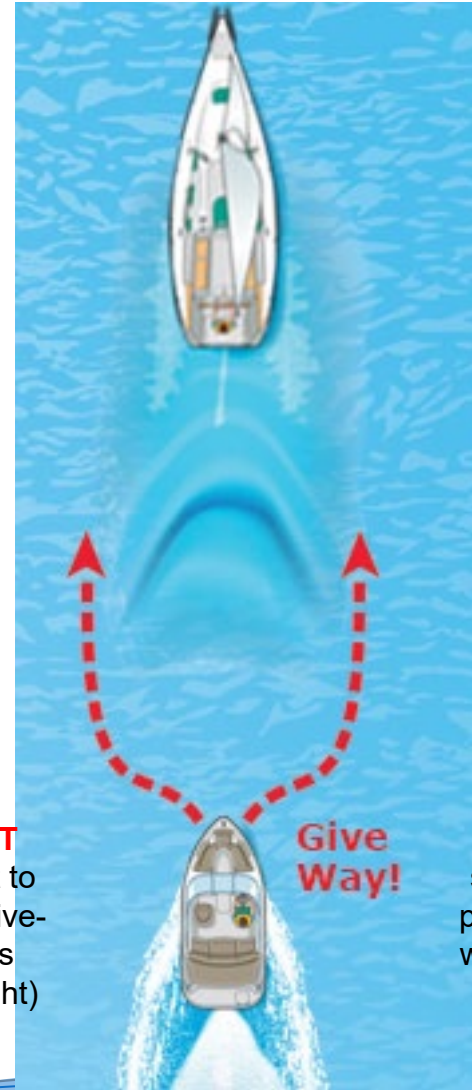

TOOT TOOT
signals intent to
pass on the give-
way vessel's
starboard (right)
side

TOOT TOOT
signals intent to
pass on the give-
way vessel's port
(left) side

Night Navigation

- ◆ **Boats must use navigation lights:**
 - From sunset to sunrise
 - When visibility is restricted
- ◆ **Lights tell you:**
 - If the other vessel is power-driven or under sail
 - Which way the other vessel is going
- ◆ **Follow the same navigational rules used in the daytime.**

Night Navigation

When you are in a **power-driven vessel** and you see a **green and a white light**, you are the stand-on vessel. You should remain alert, however, in case the other vessel operator does not see you or does not know navigational rules.



Night Navigation

When you are in a **power-driven vessel** and you see only a **white light**, you are overtaking another vessel or it is anchored. It is the stand-on vessel, whether underway or anchored. You may go around it on either side.



Night Navigation

When you are in a **power-driven vessel** and you see a **red and a white light**, you must give way to the other vessel. Slow down and allow the vessel to pass, or you may turn to the right and pass behind the other vessel.



Night Navigation

When you are in a **power-driven vessel** and you see a **red, a green, and a white light**, you are approaching another power-driven vessel head-on and both vessels must give way.



Night Navigation

When you are in **any type of vessel** and you see a **red and a green light but no white light**, you are approaching a sailing vessel head-on and you must give way.

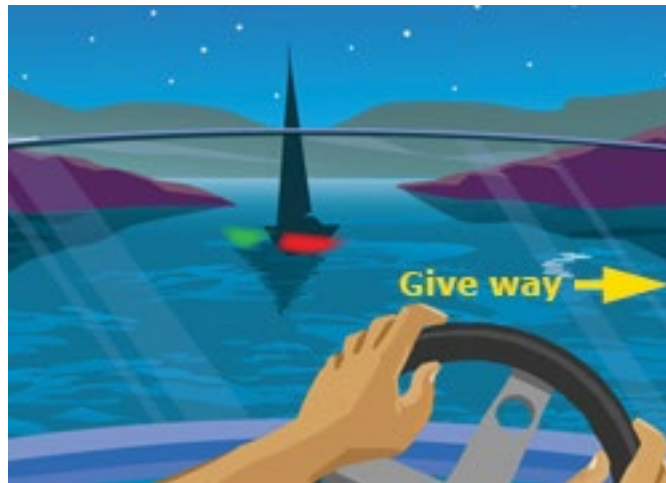

Night Navigation

When you are in **any type of vessel** and you see **only a green light or only a red light**, you may be approaching a sailing vessel and you must give way. A sailing vessel is always the stand-on vessel except when it is overtaking.



Night Navigation

Towing Lights

When commercial vessels are towing, they display one or more yellow lights in place of a sternlight.

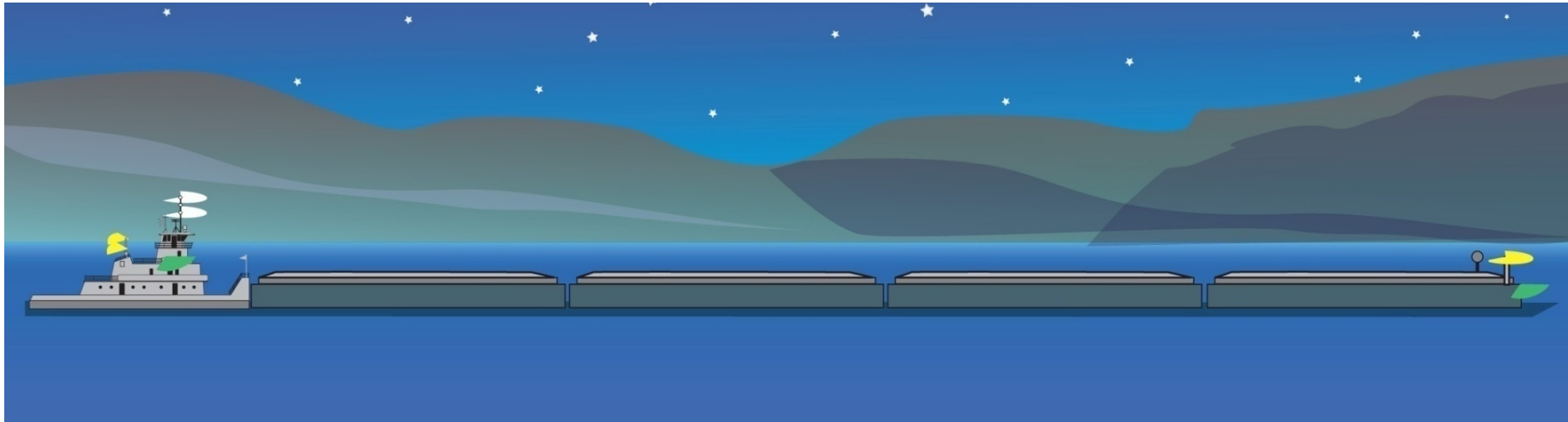

Sound Signals

- ◆ **Sound signals use short and prolonged blasts. They must be audible for at least one-half mile.**
 - **Short blast—about one second in duration**
 - **Prolonged blast—4–6 seconds in duration**

Sound Signals

- ◆ **Change in Direction**
 - **One short blast**
 - **Two short blasts**
 - **Three short blasts**

Sound Signals

◆ Poor Visibility

- One prolonged blast every two minutes
- One prolonged blast + two short blasts every two minutes

Sound Signals

◆ Danger

- One prolonged blast
- Five or more short, rapid blasts

U.S. Aids to Navigation System

Lateral Markers

**Can Buoys:
Green With Odd Numbers**



**Nun Buoys:
Red With Even Numbers**

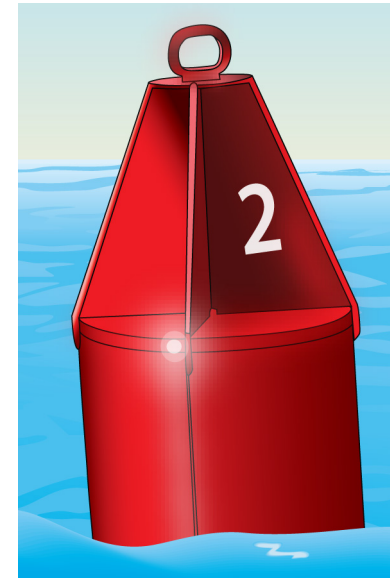

U.S. Aids to Navigation System

Lighted Buoys

Green Colors and Lights



Red Colors and Lights



U.S. Aids to Navigation System

Daymarks (on a fixed post or piling)

Reflective Green, Odd Numbers



Reflective Red, Even Numbers

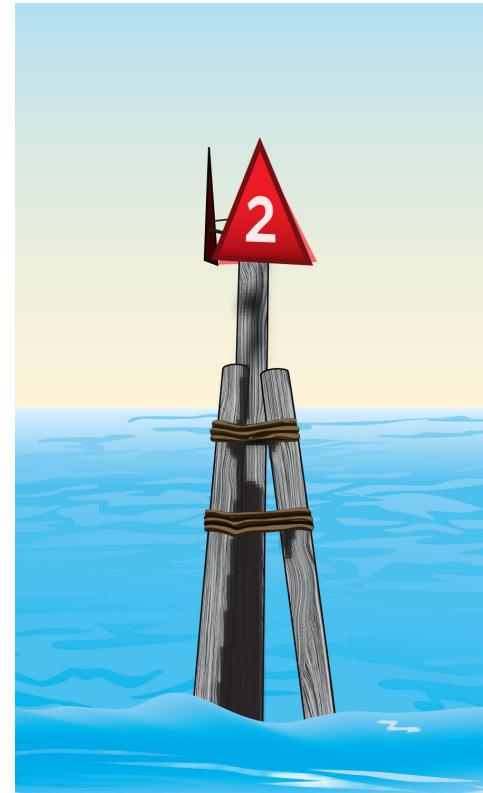

U.S. Aids to Navigation System

“Red Right Returning”



U.S. Aids to Navigation System

Lateral Markers—(ICW)

Keep on your port (left) side



Keep on your starboard (right) side

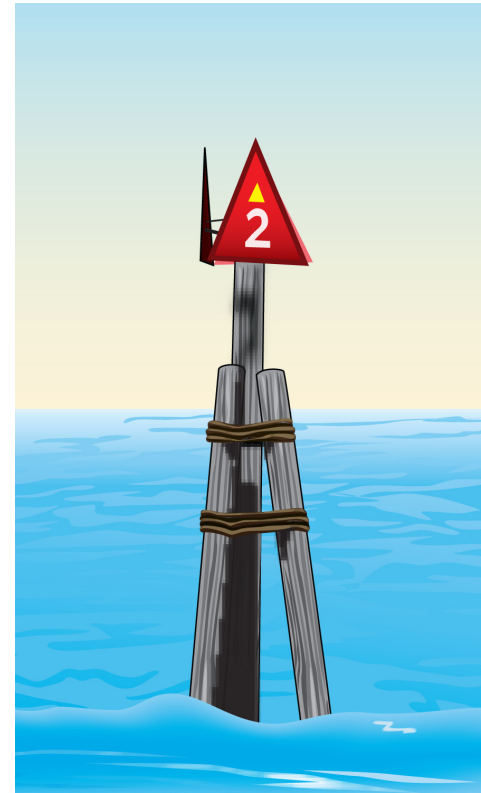

U.S. Aids to Navigation System

Western Rivers System Marker

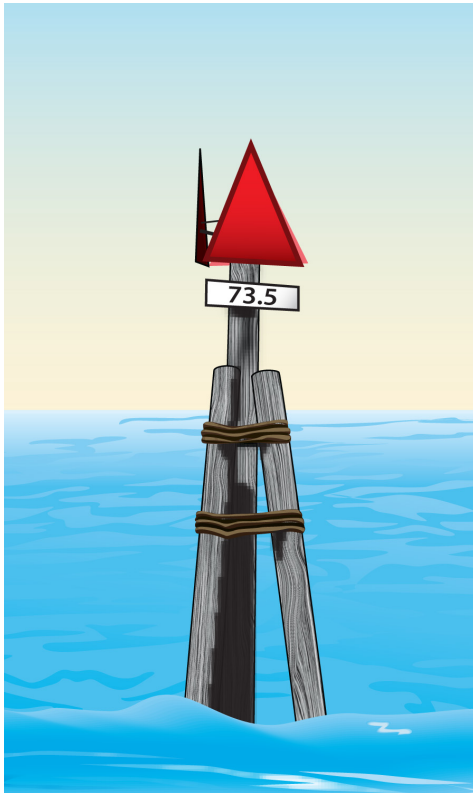

**Indicates 73.5 miles from the
river's mouth**

U.S. Aids to Navigation System

Non-Lateral Markers

Information



Danger Area



U.S. Aids to Navigation System

Non-Lateral Markers

Controlled Area



Exclusion Area



U.S. Aids to Navigation System

Other Non-Lateral Markers

Safe Water Markers

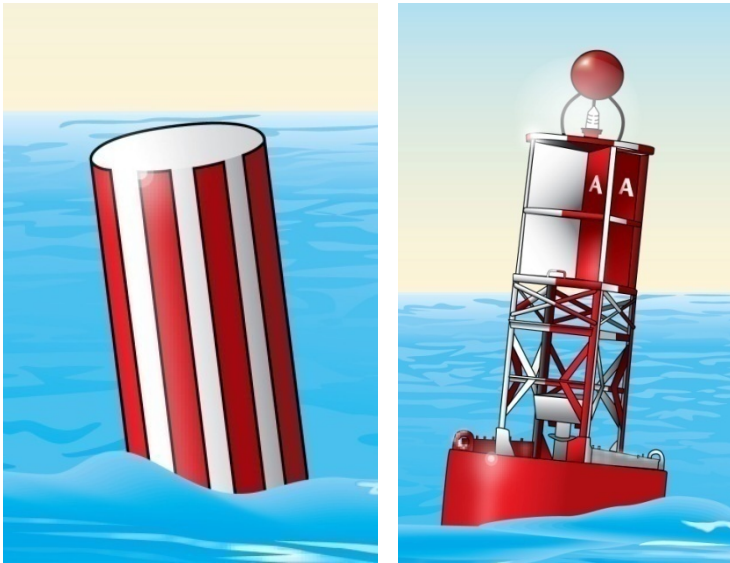

Inland Waters Obstruction Marker

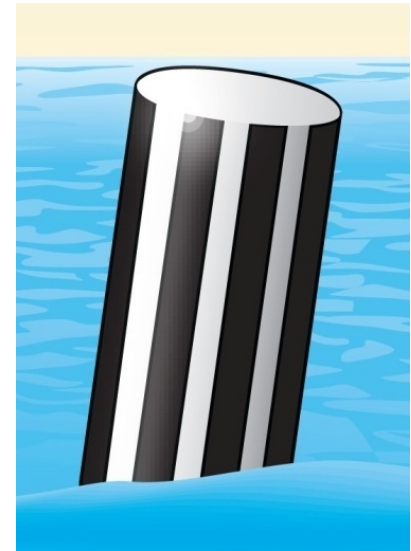

U.S. Aids to Navigation System

Other Non-Lateral Markers

Mooring Buoys

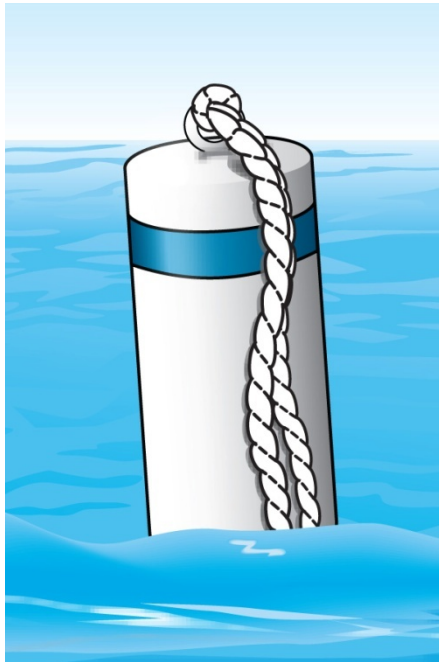

U.S. Aids to Navigation System

Special Markers—Yellow Can Buoys

- ◆ Found on Lake Erie, west of Port Clinton, at the Erie Proving Grounds/Camp Perry Firing Range.
 - Firing Range 2 is marked by 12 yellow can buoys with the letters A–L.
 - Firing Range 1 is marked by danger buoys, which are white with orange diamonds.
- ◆ Yellow cans also mark the border between Canada and the U.S.

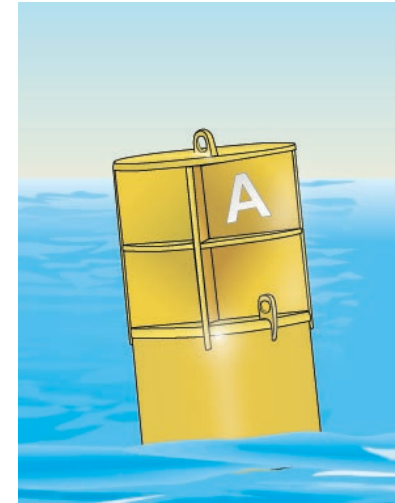

Anchoring

Even though anchors are used most often by recreational boaters to “park” their boats while swimming or fishing, anchors are also critical equipment in times of emergency. Anchoring may be a safety measure if your boat becomes disabled.

Anchoring

Choose an anchor that fits your boat and the boating conditions.

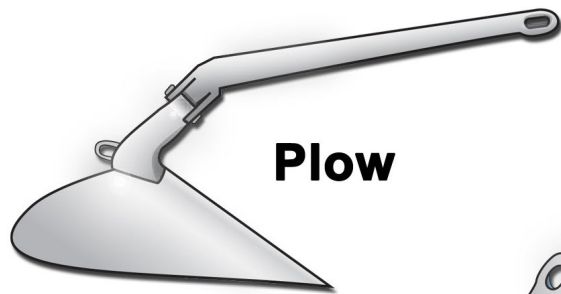

◆ Plow-Style Anchor

Good for most boats and gets its holding power by plowing into bottom sediments.

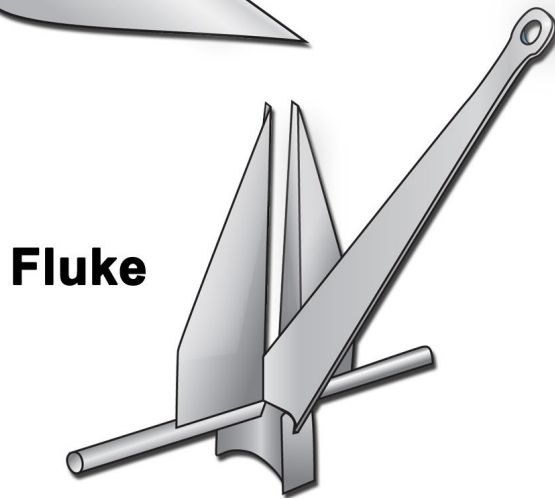

◆ Fluke-Style Anchor

Similar to plow style but is more lightweight. It is also good for most boats and gets its holding power from its pointed flukes digging into bottom sediments.

Anchoring

◆ Mushroom-Type Anchor

- Gets its holding power by sinking into bottom sediments.
- Should not be used to anchor boats larger than a small canoe, rowboat, small sailboat, or inflatable boat because the holding power is weak.
- Never depend on a mushroom anchor to hold your boat in rough water or weather.

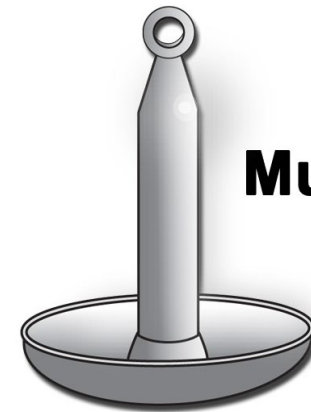

Mushroom

Anchoring

Prepare Your Anchor Before Setting Out

- ◆ **Attach 7–8 feet of galvanized chain to the anchor.**
- ◆ **Length of line should be at least 7–10 times the depth of the water where the anchor will be set.**
- ◆ **Because an anchor can be a safety device in an emergency situation, store the anchor and its lines in an accessible area.**
- ◆ **If the engine breaks down, you may need to anchor quickly to avoid drifting aground.**

Anchoring

Steps to Anchor Your Boat

- ◆ **Select an area with plenty of room. Ideally, a well-protected area with adequate water depth and a sandy or muddy bottom.**
- ◆ **Head slowly into the wind or current to a position upwind or upcurrent of where you actually want to end up.**
- ◆ **Stop the boat, and slowly lower the anchor over the bow to the bottom. *Never anchor from the stern as this can cause the boat to swamp.***

Anchoring

- ◆ **Slowly back the boat away downwind or downcurrent. Tie off the line around a bow cleat, and pull on the anchor line to make sure the anchor is set.**
- ◆ **After anchoring, take visual sightings of onshore objects or buoys in the water to help you know where your boat is positioned.**
- ◆ **Periodically check connecting knots on your anchor line. When possible, use splices instead of knots. Knots weaken a line more than splices.**

Anchoring

Steps to Retrieve Your Anchor

- ◆ **Move the boat directly over the anchor while pulling in the line. Pulling the anchor straight up should break it free.**
- ◆ **If the anchor is stuck, turn your boat in a large circle while keeping the anchor line pulled tight.**
- ◆ **When the anchor breaks loose, stop the boat, and retrieve the anchor. Never drag the anchor behind the boat.**

Dams, Locks, and Bridges

Dams

- ◆ Pose danger both above and below the dams.
- ◆ Low-head dams:
 - Most dangerous type of dam and named the “drowning machine.”
 - Cannot be easily spotted because the top of a low-head dam is several feet below the water’s surface.
 - On large rivers or during high water, the backroller or boil may be located more than 100 feet downstream of the dam. Avoid low-head dams.

Dams, Locks, and Bridges

Dams

◆ Large-structure dams:

- More easily spotted because of their powerhouses and spillways.
- Can be dangerous to boaters both below and above the dam.
- Areas are usually off-limits.
- Obey all warning signs and signals.

Dams, Locks, and Bridges

Locks

- ◆ Lock attendants are present at most locks to help you through safely.
- ◆ As a result of a dam, there will be two levels of water at the dam site—one level above the dam and a different one below. Locks safely transport boats from one water level to another, like an elevator.

Dams, Locks, and Bridges

Approaching the Dock

- ◆ **Be aware that commercial traffic always has priority over recreational boats. Wait at least 400 feet away from the lock for the signal to enter the lock.**
- ◆ **Sound one prolonged blast followed by one short blast of your boat's whistle to alert the lock attendant that you wish to go through the lock.**
- ◆ **Enter the lock only after you've been signaled to enter by the lock's traffic lights.**

Dams, Locks, and Bridges

When using locks, boaters should...

- ◆ Have fenders and at least 100 feet of rope to use in securing a boat inside the lock.
- ◆ Follow the lock attendant's instructions and proceed slowly.
- ◆ Avoid passing another boat when inside the lock, unless directed to do so by the lock attendant.
- ◆ Wait for the lock attendant's signal to exit the lock.

Dams, Locks, and Bridges

Bridges

- ◆ Reduce speed and proceed with caution.
- ◆ Check clearance before passing under a bridge.
- ◆ For drawbridges, contact the bridge operator.
- ◆ Watch for debris that collects around pilings.



Changing Water Levels

- ◆ **Be aware that water levels can change rapidly and cause hazards.**
 - **Running aground**
 - **Docking to a fixed pier**
- ◆ **Learn about the tides when boating on coastal waters.**
 - **Fluctuating water levels**
 - **Strong tidal currents**

Compasses and Charts

Steering Compass



- ◆ Can be invaluable in bad weather at night.
- ◆ Mount it away from iron, magnets, and electrical wiring and equipment.

Compasses and Charts

Nautical Charts

- ◆ In bays or large lakes, charts give:
 - Water depths
 - Locations of channels, sand bars, rocks, and vegetation
 - Most direct course possible

Compasses and Charts

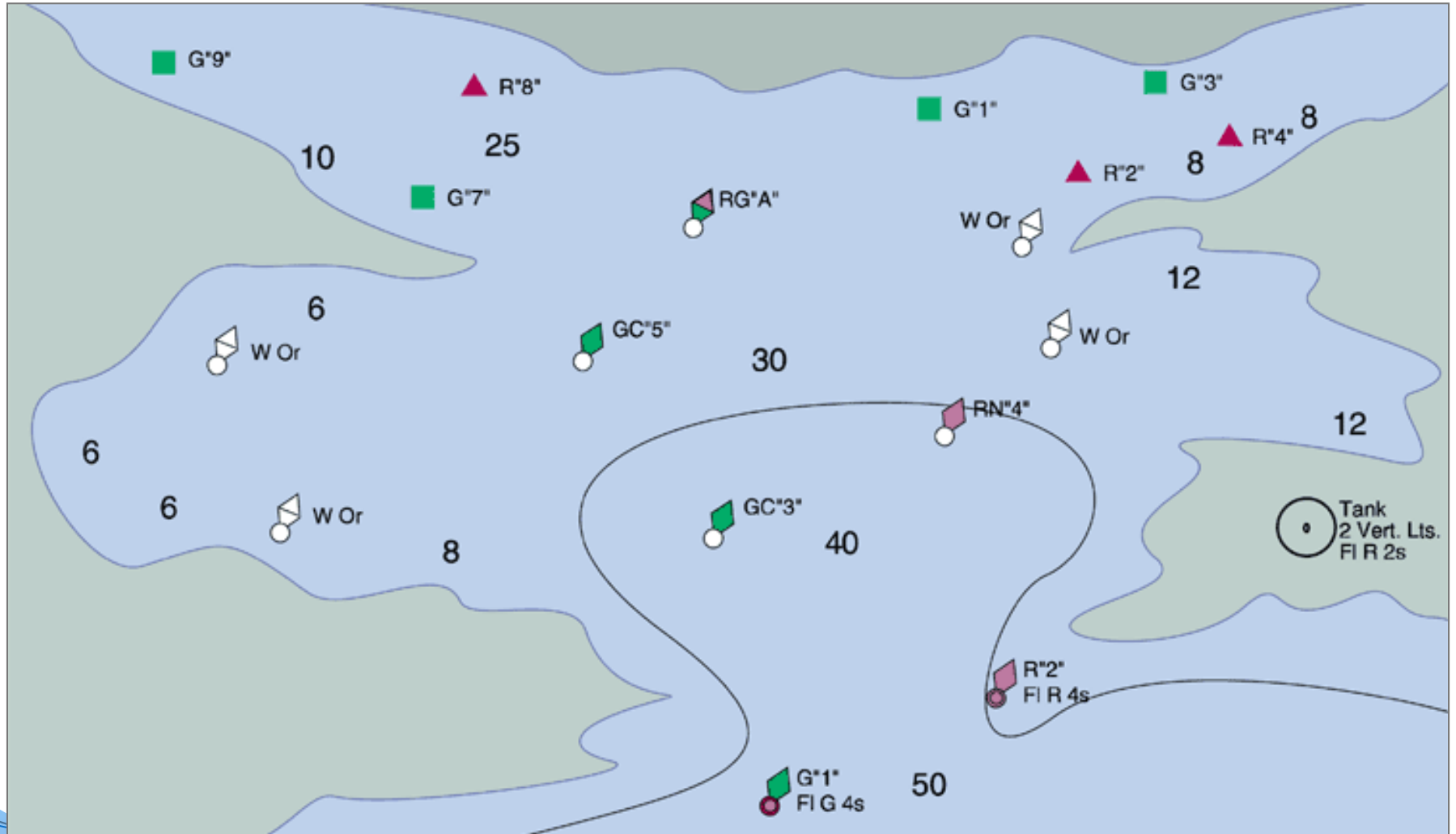

Operating a Personal Watercraft

Steering and Stopping a PWC

- ◆ Most PWC (and other jet-drive vessels) must have power to maintain control.



The operator is holding down the throttle lever and steering the PWC straight ahead.

Operating a Personal Watercraft

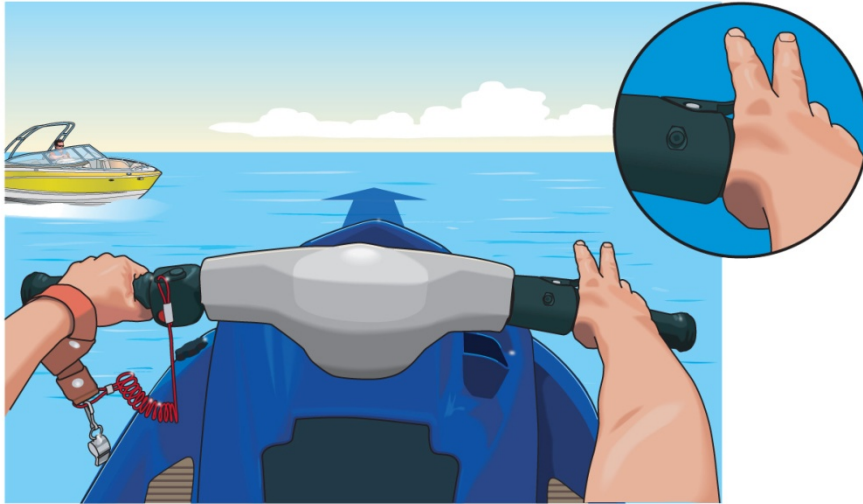

The operator releases the throttle lever.



The PWC may continue to go straight ahead even though the operator is trying to turn.

◆ Newer PWC allow for off-throttle steering.

Operating a Personal Watercraft

Environmental Considerations

- ◆ **Make sure that the water you operate in is at least 30 inches deep. Riding in shallow water can cause bottom sediments or aquatic vegetation to be sucked into the pump, damaging your PWC and the environment.**
- ◆ **Avoid causing erosion by operating at slow speeds and by not creating a wake when operating near shore or in narrow streams or rivers.**

Operating a Personal Watercraft

Environmental Considerations

- ◆ Do not dock or beach your PWC in reeds and grasses. This could damage fragile environments.
- ◆ Take extra care when fueling your PWC in or near the water. Oil and gasoline spills are very detrimental to the aquatic environment. Fuel on land if possible.
- ◆ Never use your PWC to disturb, chase, or harass wildlife.

Operating a Personal Watercraft

Other PWC Considerations

- ◆ Know the PWC regulations for your state.
- ◆ Wear a PFD.
- ◆ Make sure passenger can hold on securely.
- ◆ Do not seat a passenger in front of the operator.



Operating a Personal Watercraft

- ◆ Keep hands, feet, loose clothing, and hair away from the pump intake area.
- ◆ Wear a wetsuit or clothing that provides equivalent protection.
- ◆ Do not board PWC if operator is applying the throttle.



Operating a Personal Watercraft

- ◆ **Inspect your electrical systems and perform “sniff test” after fueling.**
- ◆ **Avoid overloading.**
- ◆ **Know your limits and ride according to your abilities.**

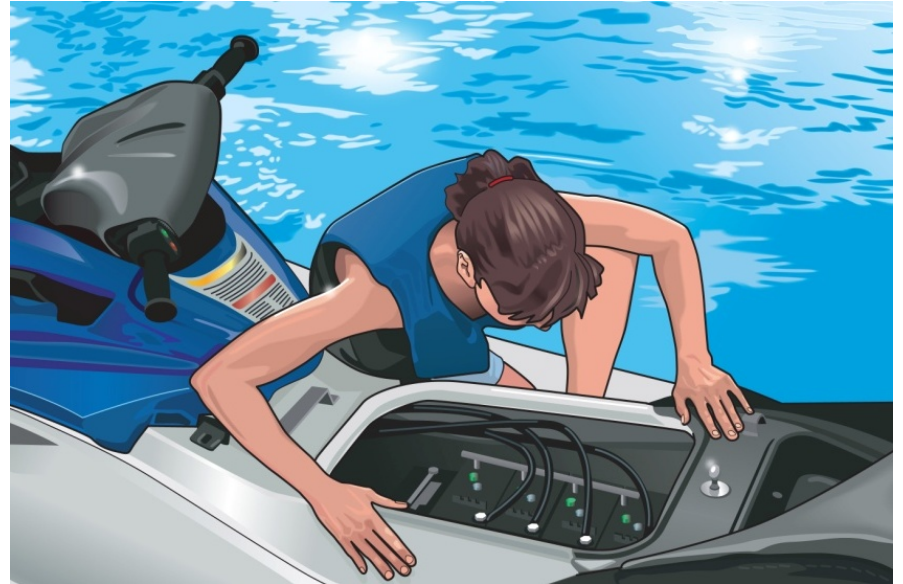

Operating a Personal Watercraft



- ◆ Look over both shoulders before making turns.

Engine Cut-Off Switches

- ◆ Safety switch
- ◆ Lanyard
- ◆ Self-circling feature

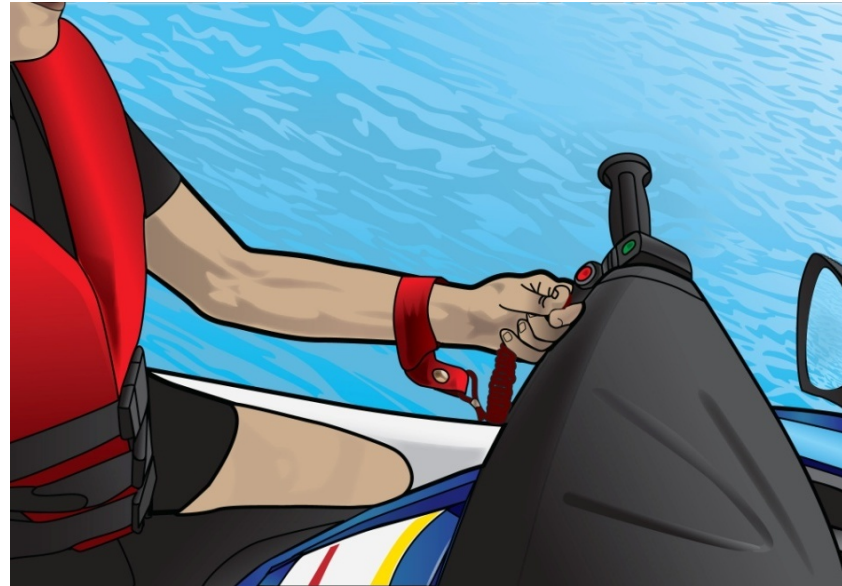

Avoiding Propeller Strike Injuries

- ◆ Turn off the engine when:
 - Passengers are boarding or disembarking.
 - Someone is in the water near the boat.
- ◆ Prevent passengers from being thrown overboard accidentally.
 - Never start with the engine in gear.
 - Never ride on the seat back, gunwale, transom, or bow.
 - Make sure all passengers are properly seated.
 - Assign someone to watch children.

Avoiding Propeller Strike Injuries

- ◆ **Maintain a proper lookout for people in the water.**
 - **Slow down when approaching congested areas and anchorages.**
 - **Learn to recognize warning buoys.**
 - **Keep the boat away from marked swimming and diving areas.**

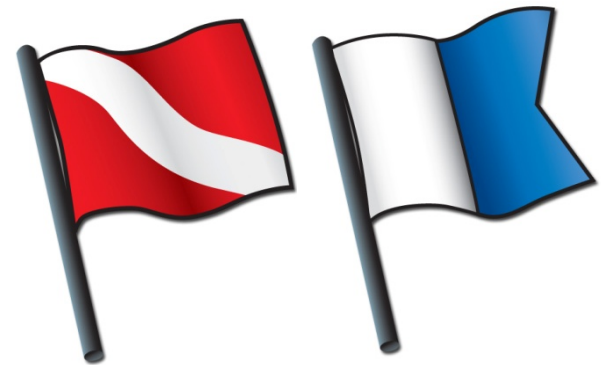

Avoiding Propeller Strike Injuries

Devices That Reduce Propeller Strikes

- ◆ Guards
- ◆ Propulsion
- ◆ Interlocks
- ◆ Sensors

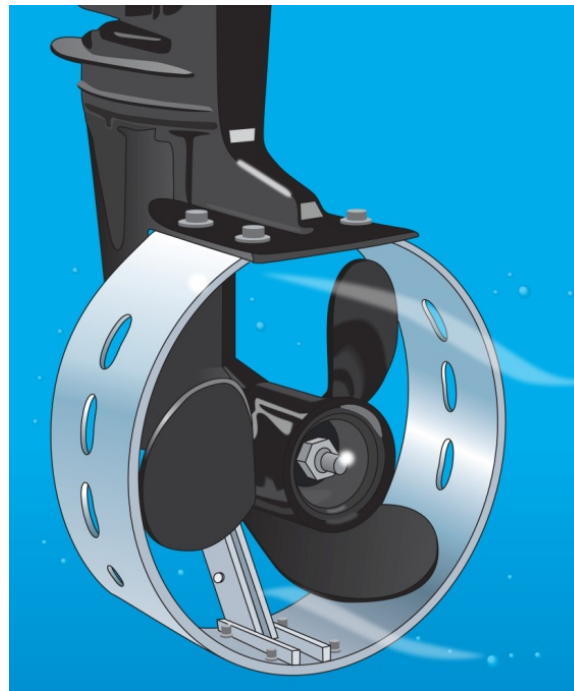

Lesson Four

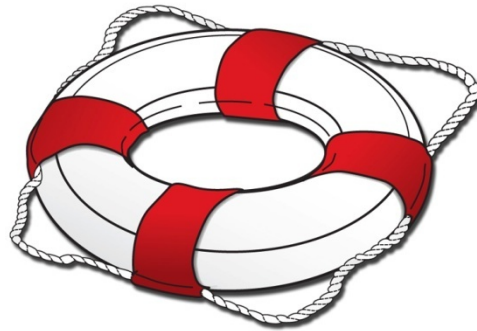

The Legal Requirements of Boating

Key Topics

- ◆ **Numbering and Documentation**
- ◆ **Hull Identification Number**
- ◆ **Age and Education Requirements**
- ◆ **Unlawful Operation**
- ◆ **Alcohol and Drugs**
- ◆ **Obstructing Navigation**

Key Topics

- ◆ **Homeland Security**
- ◆ **Personal Flotation Devices**
- ◆ **Fire Extinguishers**
- ◆ **Flame Arrestors, Ventilation, and Mufflers**
- ◆ **Navigation Lights**
- ◆ **Visual Distress Signals**
- ◆ **Sound-Producing Devices**

Key Topics

- ◆ **Other Equipment and Regulations**
- ◆ **Personal Watercraft Laws**
- ◆ **Laws Relating to Towing Persons**
- ◆ **Waste, Oil, and Trash Disposal**
- ◆ **Protecting the Environment**
- ◆ **Reporting Accidents**
- ◆ **Enforcement**

Objectives

You should be able to...

- ◆ Tell which vessels need to be registered and how to do so.
- ◆ Place certificate numbers and validation decals on a vessel correctly.
- ◆ Find the hull identification number (HIN) on a vessel.
- ◆ Explain the age and education restrictions on vessel or personal watercraft (PWC) operation.

Objectives

- ◆ **List the reckless or negligent behaviors that should be avoided when operating a vessel.**
- ◆ **Explain the dangers of consuming alcohol or drugs while boating and the penalties for doing so.**
- ◆ **Tell the laws pertaining to obstructing navigation.**
- ◆ **Explain your role in keeping waterways safe and secure.**

Objectives

- ◆ **Identify the classifications and uses of personal flotation devices (PFDs), and state the legal requirements.**
- ◆ **Tell the legal requirements for fire extinguishers, backfire flame arrestors, ventilation systems, and mufflers.**
- ◆ **Tell the legal requirements for navigation lights, visual distress signals, and sound-producing devices.**

Objectives

- ◆ **Tell the requirements for other equipment such as diver-down flags or state-required equipment.**
- ◆ **List the legal requirements specific to PWC.**
- ◆ **List the legal requirements for towing a person behind a vessel.**
- ◆ **Explain how to dispose of waste, trash, and oil properly and how to use marine sanitation devices (MSDs) properly.**
- ◆ **Tell when and how to report a boating accident.**

Certificate of Number and Decal

- ◆ You must have a Certificate of Number and a validation decal(s) to operate your vessel legally.
- ◆ Registration card must be carried on board whenever the vessel is being operated.

Certificate of Number and Decal

- ◆ **State laws vary. Check with your state's boating agency for specific requirements.**
 - **Placement of decals**
 - **Expiration**

Other Facts About Titling and Registration

In your state:

- ◆ **Is a title required for a vessel?**
- ◆ **Is a title required for an outboard motor?**
- ◆ **When do the Certificate of Number and validation decal expire?**
- ◆ **What should you do if a vessel is transferred, destroyed, abandoned, lost, stolen, or recovered?**

Other Facts About Titling and Registration

In your state:

- ◆ What should you do if a Certificate of Number or validation decal is lost or destroyed?
- ◆ What should you do if your address changes?
- ◆ How do you apply for a U.S. Coast Guard “Certificate of Documentation” for a larger recreational vessel?

Hull Identification Number

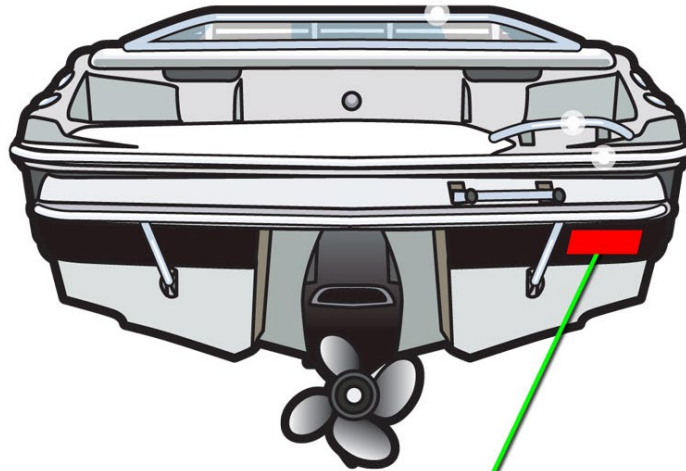

ABC 67689 B6 06

Manufacturer's
Identification
Code (MIC)

Hull Serial
Number

Date of
Manufacture

Model
Year

The Hull Identification Number (HIN) is a 12-digit number that uniquely identifies a vessel.

Who May Operate a Vessel

In your state:

- ◆ How old must a person be to operate a boat, personal watercraft (PWC), or vessel with a specific horsepower?
- ◆ Which persons must take a boating safety education course?

Who May Operate a Vessel

In your state:

- ◆ Which persons must have an adult on board the vessel?
- ◆ Are operators required to carry the boater education certificate on board?
- ◆ Which persons are exempt from the boating safety education course?

Unlawful Operation of a Vessel

- ◆ **Reckless operation means boating in a way that could endanger someone's life, safety, or property.**



Unlawful Operation of a Vessel

In your state, does operating recklessly include:

- ◆ **Weaving through congested traffic?**
- ◆ **Operating in swimming areas or other restricted areas?**
- ◆ **Jumping wakes close to another vessel?**
- ◆ **Swerving at the last moment to avoid collision?**
- ◆ **Chasing or harassing wildlife?**

Alcohol and Drugs

In your state:

- ◆ How is boating while intoxicated (BWI) defined?
- ◆ What determines if a person is intoxicated, including the blood alcohol concentration percentage?
- ◆ What are the penalties for BWI?
- ◆ When have you consented to be tested?



Obstructing Navigation

It is illegal to:

- ◆ Operate in a way that keeps other vessels from navigating safely.
- ◆ Anchor in a river or channel in a place that is in the way of other vessels passing through.
- ◆ Moor or attach vessel to buoy, beacon, light, or any other navigational aid.
- ◆ Move, damage, or destroy any navigational aid.
- ◆ Block access to a pier, wharf, boat ramp, or any facility.

Homeland Security Restrictions

- ◆ Slow to minimum speed within 500 yards of any U.S. Naval vessel. Do not approach within 100 yards.
- ◆ Observe and avoid all security zones.
- ◆ Observe and avoid restricted areas near dams, power plants, etc.
- ◆ Do not stop or anchor beneath bridges or in channels.
- ◆ Do your part to keep our waterways safe and secure.

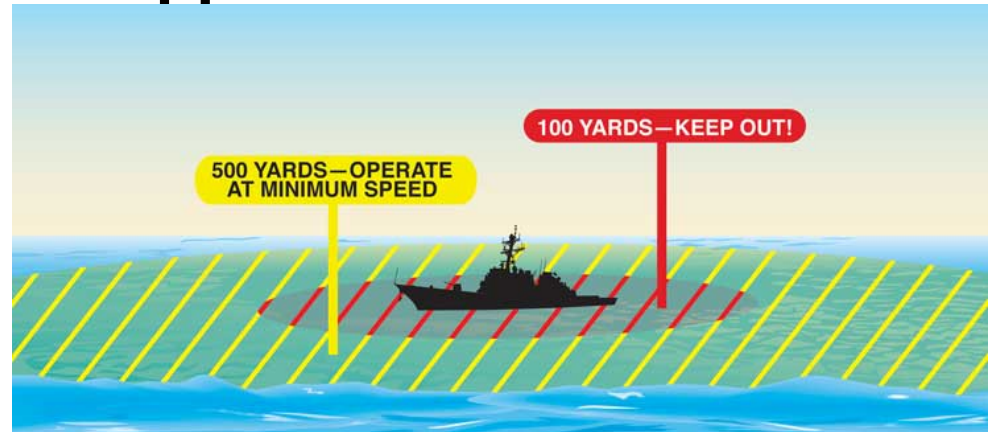

Personal Flotation Devices (PFDs)

- ◆ All vessels must have one wearable USCG–approved personal flotation device (PFD), sometimes called life jacket, of a proper size for each person on board.

Type I:

Wearable Offshore Life Jackets



Type II:

Wearable Near-Shore Vests



Personal Flotation Devices

Type III: Wearable Flotation Aids

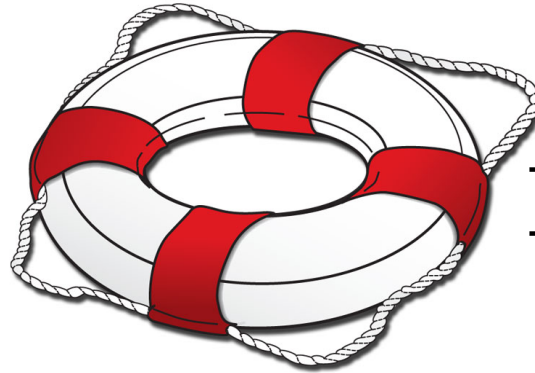

Type IV:
Throwable Devices

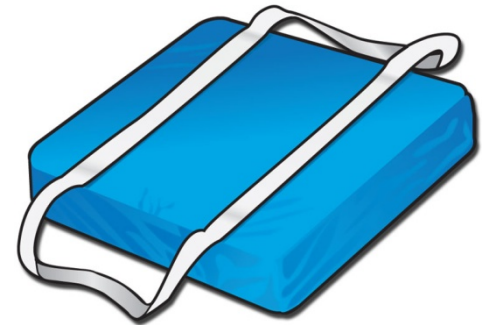

Type V:
Special-Use Devices



Personal Flotation Devices

In your state:

- ◆ **What are the laws regarding PFDs?**
- ◆ **What types must be carried on board?**
- ◆ **Which vessels must have a Type IV throwable device on board?**

Personal Flotation Devices

In your state:

- ◆ What are the PFD requirements in these situations?

Children



Persons on PWC



Persons being towed behind a vessel



Fire Extinguishers

Classification of Fires

- ◆ **Type A** fires are of combustible solids such as wood. On Type A extinguishers, the number relates to how many gallons of water the extinguisher is equal to for a Type A fire.
- ◆ **Type B** fires are of flammable liquids such as gasoline or oil. On Type B extinguishers, the number tells you the square footage of the fire the extinguisher can put out.
- ◆ **Type C** fires are electrical fires. Type C extinguishers do not use numbers.

Fire Extinguishers

Fire Extinguisher Requirements

Length of Vessel	Without Fixed System	With Fixed System
Less than 26 feet	one 5-B	none
26 feet to less than 40 feet	two 5-B or one 20-B	one 5-B
40 feet to less than 65 feet	three 5-B or one 20-B and one 5-B	two 5-B or one 20-B

For carriage requirements, one 5-B is equivalent to one B-I, and one 20-B is equivalent to one B-II.

Fire Extinguishers

- ◆ Extinguishers should be placed where they are accessible and can be reached immediately.
- ◆ Check the following on a regular basis.
 - Seals and tamper indicators are not broken or missing.
 - The extinguisher is fully charged.
 - There is no physical damage.
- ◆ **In your state**, are any vessels exempt from the fire extinguisher requirement?

Backfire Flame Arrestors

- ◆ Prevent ignition of gasoline vapors if engine backfires.



Backfire Flame Arrestors

- ◆ **Must be:**
 - **On each carburetor.**
 - **In good working condition.**
 - **USCG–approved.**
- ◆ **Should be cleaned periodically and checked for damage.**

Ventilation Systems

- ◆ Gasoline-powered vessels built to trap fumes must have a natural ventilation system.

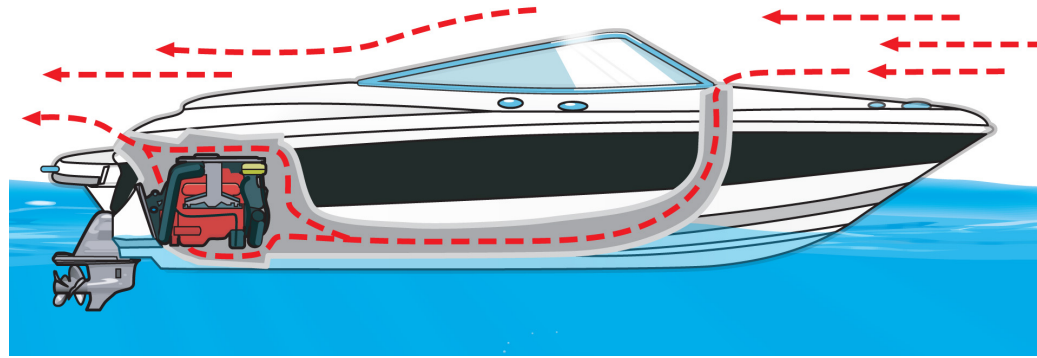

- ◆ If your vessel has a power ventilation system, let it run for at least four minutes before starting the engine.

Mufflers and Noise Level Limits

In your state:

- ◆ What type of muffling system is required?
- ◆ What are the noise level limits?
- ◆ What modifications are prohibited?

Navigation Lights

- ◆ **Vessel must be equipped with proper navigation lights.**
- ◆ **Lights must be used:**
 - **Between sunset and sunrise**
 - **When visibility is limited**

Navigation Lights

Power-Driven Vessels Less Than 39.4 Feet

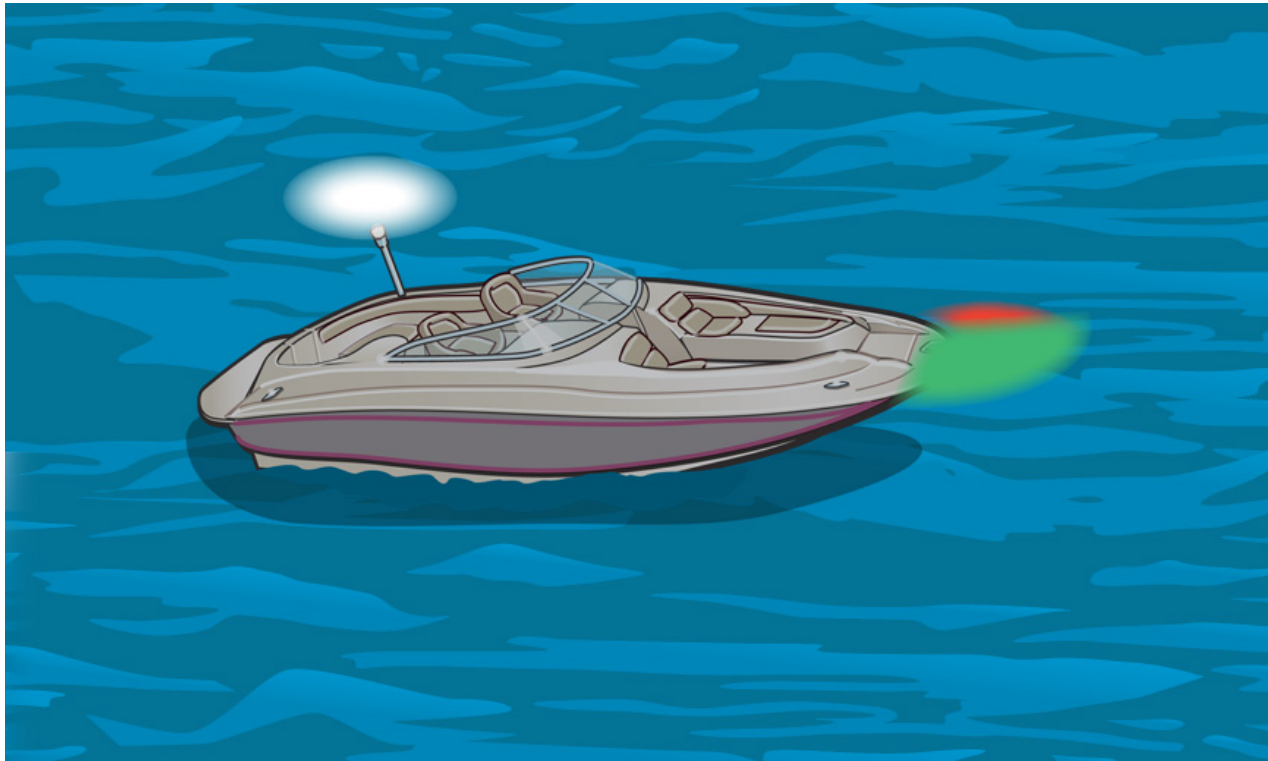

Navigation Lights

Power-Driven Vessels Less Than 65.6 Feet

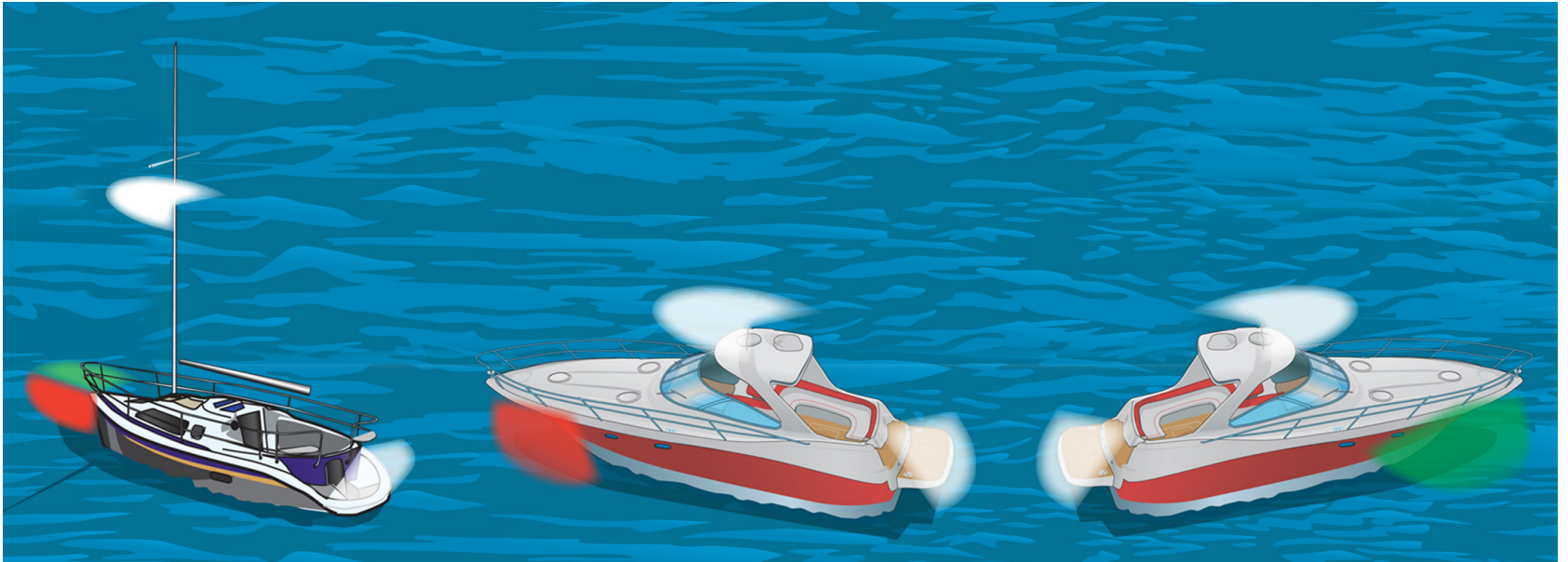

Navigation Lights

Unpowered Vessels Less Than 65.6 Feet

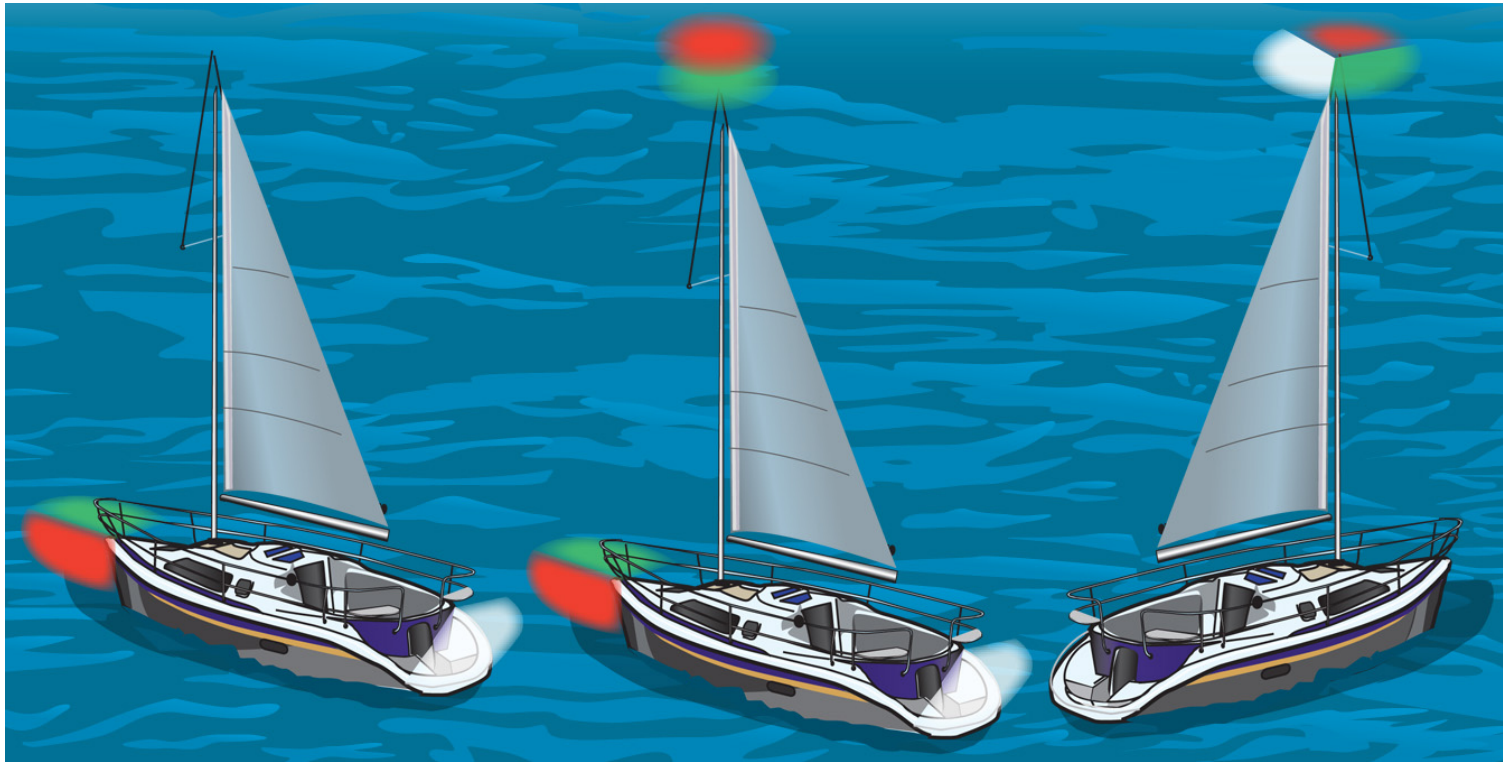

Navigation Lights

Unpowered Vessels Less Than 23 Feet



Navigation Lights

All Vessels When Not Underway



Visual Distress Signals

- ◆ **Visual distress signals (VDSs) are classified as:**
 - **Day signals**
 - **Night signals**
 - **Both day and night signals**
- ◆ **VDSs are either:**
 - **Pyrotechnic**
 - **Non-pyrotechnic**

Visual Distress Signals

- ◆ **Vessels on federally controlled waters must carry USCG–approved VDSs.**
 - **All vessels must carry night signals when operating at night.**
 - **Most vessels must carry day signals also.**



Visual Distress Signals

Pyrotechnic VDSs



**Orange Smoke
Day Signal**



**Red Meteor
Day & Night Signal**



**Red Flare
Day & Night Signal**

Non-Pyrotechnic VDSs



**Electric Light
Night Signal**



**Orange Flag
Day Signal**

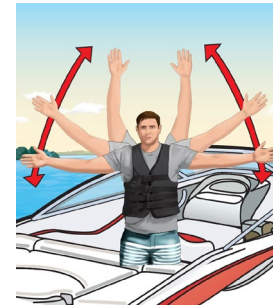

Arm Signal

Visual Distress Signals

- ◆ **If pyrotechnic VDSs are used:**
 - **You must carry a minimum of three on board.**
 - **They must be dated. Expired VDSs may be carried on board, but a minimum of three unexpired VDSs must be carried in the vessel.**

Visual Distress Signals

Example Combinations

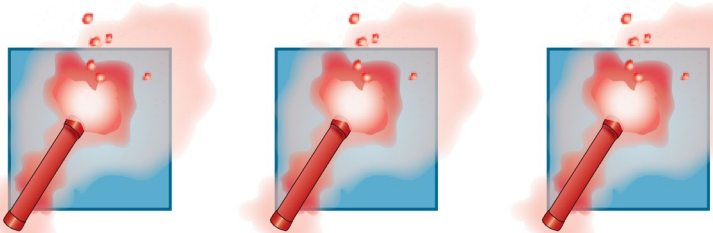

3 handheld red flares

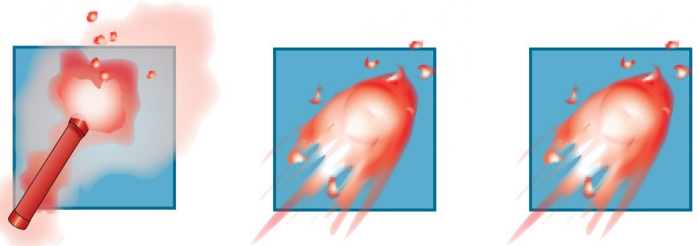

**1 handheld red flare
2 red meteors**

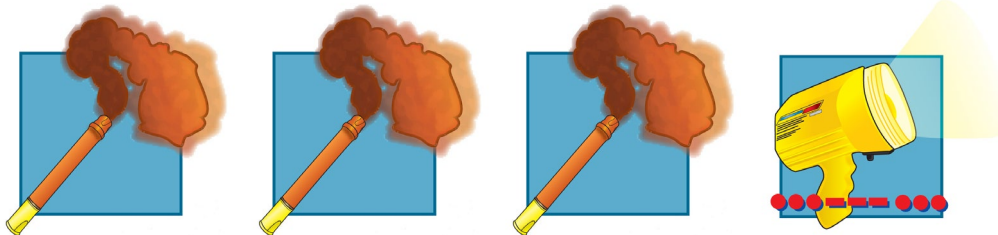

**3 orange smoke signals
1 electric light**

Sound-Producing Devices

- ◆ Are essential when visibility is limited.
- ◆ Let other boaters know what you plan to do.

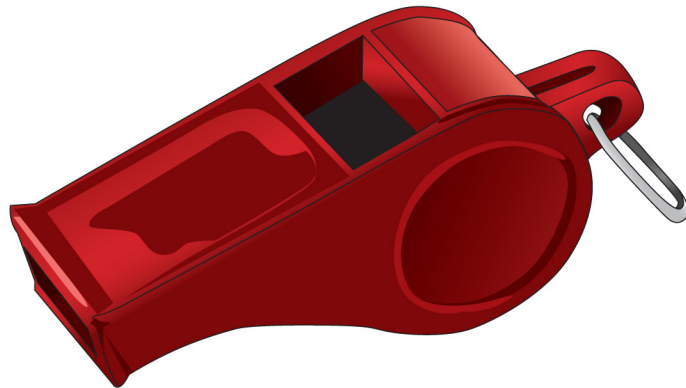

Sound-Producing Devices

Types of Sound-Producing Devices

◆ Whistle

◆ Horn

◆ Bell



Sound-Producing Devices

- ◆ **Requirements for federally controlled waters:**
 - **Vessels less than 39.4 feet (12 meters) in length, which includes PWC, must have some way of making an efficient sound signal. Examples are a handheld air horn, an athletic whistle, an installed horn, etc. A human voice is not acceptable.**
 - **Vessels that are 39.4 feet (12 meters) or more in length must have a sound-producing device that can produce an efficient sound signal. The sound signal should be audible for one-half mile and should last for 4 to 6 seconds.**

Sound-Producing Devices

In your state:

- ◆ Are sound-producing devices required on your state's waters?
- ◆ What types of devices are required based on the length of the vessel?
- ◆ How far away must the sound signal be audible?

Other Equipment and Regulations

- ◆ Two types of flags may be used to indicate diving activity:



Divers Flag
red-and-white



Alfa Flag
blue-and-white

- ◆ What flags are required in your state?
- ◆ How far must a vessel stay from a diver-down flag?

Other Equipment and Regulations

In your state:

- ◆ Are permits required for marine events?
- ◆ Are you required to license and/or register your vessel's trailer?
- ◆ Are you required to have certain equipment on your trailer?
- ◆ Is any other equipment required?
- ◆ What are the local regulations for specific waterways?

Requirements Specific to PWC

In your state:

- ◆ **What are the requirements for PFDs?**
- ◆ **Are you required to have a lanyard-type engine cut-off switch? What about a self-circling feature?**
- ◆ **During what hours may you operate a PWC legally?**
- ◆ **What are the age restrictions for operating a PWC?**

Requirements Specific to PWC

In your state, do illegal activities include:

- ◆ **Jumping another vessel's wake?**
- ◆ **Weaving through traffic?**
- ◆ **Operating above "slow, no wake speed" in certain areas?**
- ◆ **Chasing, harassing, or disturbing wildlife?**
- ◆ **Any others?**

Towing a Person Legally

In your state:

- ◆ What are the requirements for PFDs?
- ◆ During what hours may you tow a person legally?
- ◆ Are you required to have an observer on board? What about a wide-angle rearview mirror?



Towing a Person Legally

In your state:

- ◆ What activities are illegal?
- ◆ Are you required to have a skier-down flag?

Waste, Oil, and Trash Disposal

Discharge of Sewage and Waste

- ◆ It is illegal to discharge waste, oil, or trash into any state or federally controlled waters.
 - Sewage carries disease.
 - Trash thrown into water can cause injuries.
 - Pollution is unsightly.
- ◆ The Refuse Act prohibits throwing, discharging, or depositing any refuse matter into U.S. waters.

Waste, Oil, and Trash Disposal

Discharge of Sewage and Waste

- ◆ **Recreational vessels with an installed toilet must have a marine sanitation device (MSD).**
 - **Types I and II MSDs treat waste.**
 - **Type III MSDs do not treat waste.**

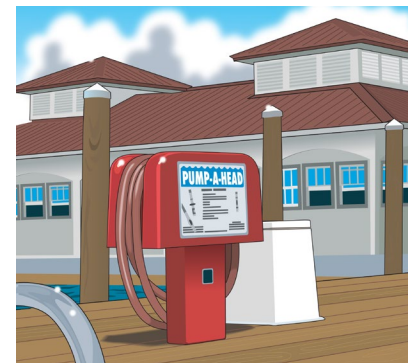
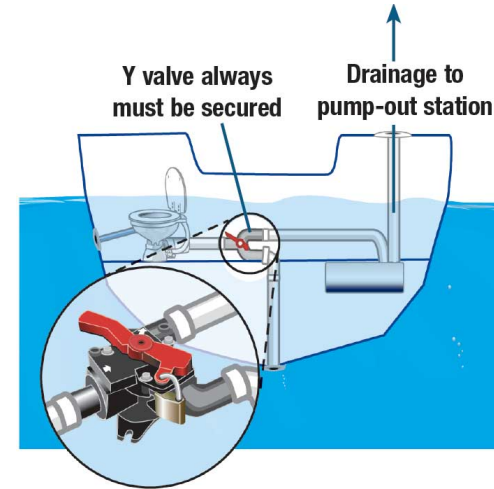

Waste, Oil, and Trash Disposal

Discharge of Sewage and Waste

- ◆ **Vessels 65 feet or less in length may use a Type I, II, or III MSD.**
- ◆ **Vessels over 65 feet in length must install a Type II or III MSD.**
- ◆ **All MSDs must have USCG certification.**
- ◆ **Are there other requirements in your state?**

Waste, Oil, and Trash Disposal

Discharge of Trash

- ◆ It is illegal to dump garbage or plastics into any state or federally controlled waters.
- ◆ Many forms of litter can kill birds, fish, and marine mammals.

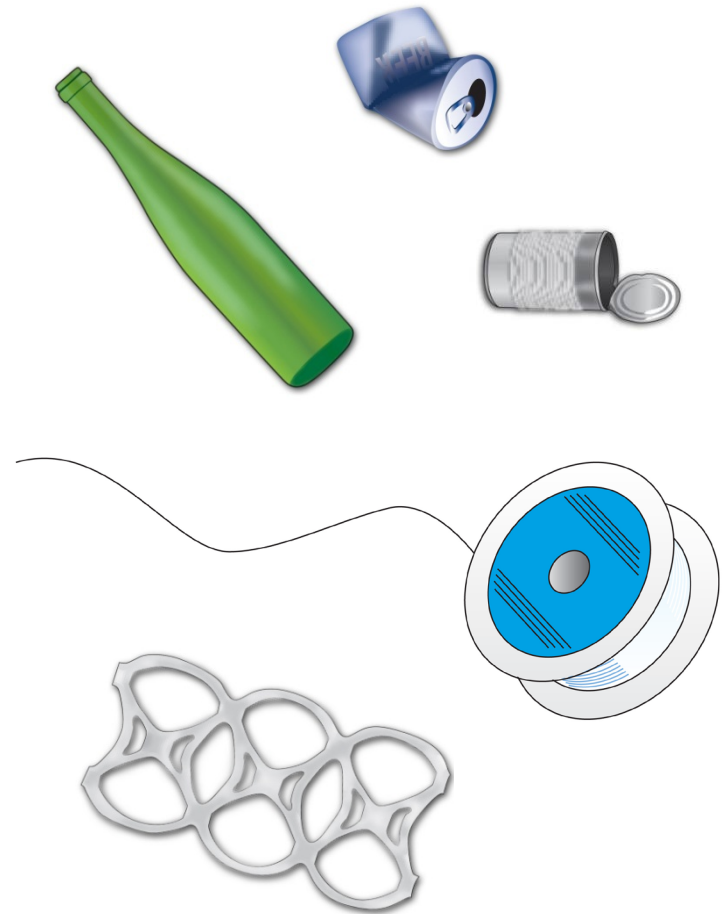

Waste, Oil, and Trash Disposal

Discharge of Trash

- ◆ On federal waters, display a 4" x 9" garbage disposal placard on any vessel 26 feet or longer.

It is illegal for any vessel to dump plastic trash anywhere in the ocean or navigable waters of the United States. Annex V of the MARPOL TREATY is a new International Law for a cleaner, safer marine environment. Each violation of these requirements may result in civil penalty up to \$25,000, a fine up to \$50,000, and imprisonment up to 5 years.

U.S. lakes, rivers, bays, sounds, and 3 miles from shore

ILLEGAL TO DUMP:

Plastic	Garbage	3 to 12 miles ILLEGAL TO DUMP: Plastic Dunnage (lining & packing materials that float) Also, if not ground to less than one inch: Garbage Metal Paper Crockery Rags Food Glass
Paper	Metal	
Rags	Crockery	
Glass	Dunnage	
Food		

12 to 25 miles

ILLEGAL TO DUMP:

Plastic
Dunnage (lining & packing materials that float)

Outside 25 miles

ILLEGAL TO DUMP:

Plastic

State and local regulations may further restrict the disposal of garbage

Working together we can all make a difference!

Waste, Oil, and Trash Disposal

Discharge of Oil and Other Hazardous Substances

- ◆ Do not discharge hazardous substances into U.S. waters.
- ◆ Do not dump oil into the bilge.
- ◆ Store and dispose of oil waste properly.

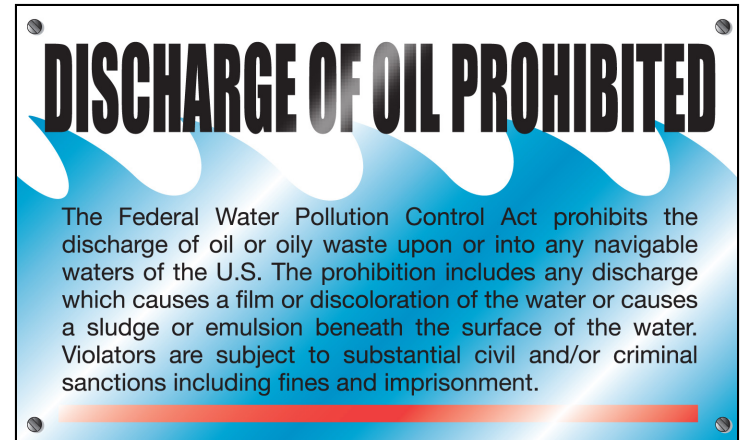

Waste, Oil, and Trash Disposal

Discharge of Oil and Other Hazardous Substances

- ◆ **Notify the National Response Center immediately if your vessel discharges oil or hazardous substances in water.**
 - **Call 1-800-424-8802 to notify the National Response Center.**
 - **What is the contact information in your state?**

Waste, Oil, and Trash Disposal

Discharge of Oil and Other Hazardous Substances

- ◆ On federal waters, vessels 26 feet or longer must display a 5" x 8" placard.

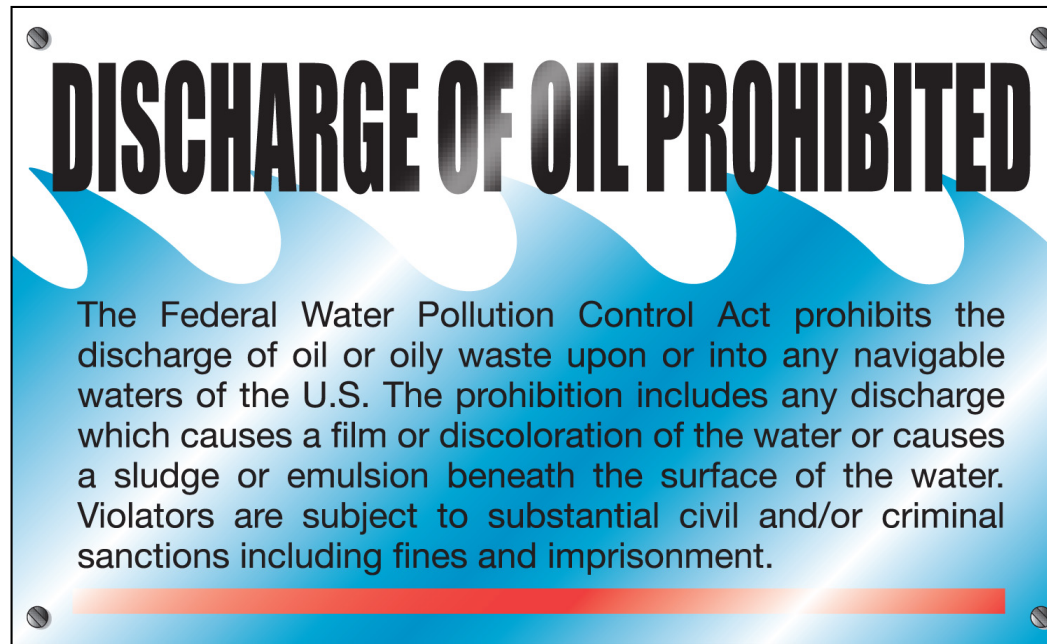

Waste, Oil, and Trash Disposal

Waste Management Plan

- ◆ **Oceangoing vessels 40 feet or longer must have written Waste Management Plan.**
- ◆ **The plan should tell how to discharge:**
 - **Sewage and hazardous waste**
 - **Garbage and food waste**
 - **Plastics, bottles, and cans**
 - **Oil or diesel fuel**

Stop Spread of Nuisance Species

- ◆ Aquatic nuisance species include zebra mussels, quagga mussels, milfoil, and hydrilla.
- ◆ Introducing these species can upset the ecosystem and hurt the environment.



Stop Spread of Nuisance Species

◆ Prevent spread of aquatic nuisance species:

- Inspect your vessel and trailer. Remove any plants and animals.
- Drain your motor, live well, and bilge on land.
- Empty your bait bucket on land.
- Rinse your vessel, propeller, trailer, and equipment.
- Air-dry your vessel and equipment.
- Stop the spread of nuisance species by following the above points.

Boating Accidents and Casualties...What the Law Requires You to Do

- ◆ **If you are involved in a boating accident, you must:**
 - **Stop immediately *and...***
 - **Assist injured persons, if it is safe to do so *and...***
 - **Give your name, address, and vessel identification.**

Boating Accidents and Casualties...What the Law Requires You to Do

In your state:

- ◆ **What types of accidents must be reported?**
- ◆ **How do you report an accident?**
 - **How soon must it be reported?**
 - **Do you report it in writing or by some other means?**
 - **To whom do you report it?**

Boating Accidents and Casualties...What the Law Requires You to Do

Sample Boating Accident Report Form

DNR Number		F. Warden <input type="checkbox"/>		OPERATOR BOATING ACCIDENT REPORT			
C.G. Number		W. Saper. <input type="checkbox"/>		Form 4100-20 (R.0/1)			
		LESS <input type="checkbox"/>					
In completing this report, do NOT fill in the shaded areas; these will be completed by the Department of Natural Resources.							
ACCIDENT CRITERIA							
Accident Criteria				Injuries Requiring Medical Treatment? <input type="checkbox"/> Yes <input type="checkbox"/> No			
Number of Boats in Accident? _____				Death Related to Accident? <input type="checkbox"/> Yes <input type="checkbox"/> No			
Complete Loss of Vessel? <input type="checkbox"/> Yes <input type="checkbox"/> No				If Yes, number of deaths: _____			
Disappearance of Person							
Indicating Injury or Death? <input type="checkbox"/> Yes <input type="checkbox"/> No							
Property Damage (Estimated)							
This Boat \$ _____		Other Boats \$ _____		Other Property \$ _____			
Date of Accident	Day of Week	Time of Day	<input type="checkbox"/> am <input type="checkbox"/> pm	Name of Body of Water	Location		
____/____/____	____	____		_____	_____		
Nearest City or Town				County		State WI	
WEATHER							
Weather (Check all applicable)		Water Conditions		Temperatures		Wind	Visibility
<input type="checkbox"/> Clear	<input type="checkbox"/> Rain	<input type="checkbox"/> Calm (Waves < 6')	Air _____ °F	<input type="checkbox"/> None		<input type="checkbox"/> Day	<input type="checkbox"/> Night
<input type="checkbox"/> Cloudy	<input type="checkbox"/> Snow	<input type="checkbox"/> Choppy (6' - 2')	Water _____ °F	<input type="checkbox"/> Light (0-6 MPH)		<input type="checkbox"/> Good	<input type="checkbox"/> Fair
<input type="checkbox"/> Fog	<input type="checkbox"/> Hazy	<input type="checkbox"/> Rough (2' - 6')		<input type="checkbox"/> Moderate (7-14 MPH)		<input type="checkbox"/> Fair	<input type="checkbox"/> Poor
		<input type="checkbox"/> Very Rough (>6')		<input type="checkbox"/> Strong (15-25 MPH)			
		<input type="checkbox"/> Strong Current		<input type="checkbox"/> Storm (Over 25 MPH)			
TYPE OF ACCIDENT				WHAT CONTRIBUTED TO ACCIDENT			
Check all applicable. If more than one, number choices in order of occurrence.				Check all applicable. If more than one, number choices in order of occurrence.			
<input type="checkbox"/> Grounding	<input type="checkbox"/> Collision with Floating Obj.	<input type="checkbox"/> Excessive Speed	<input type="checkbox"/> Careless/Reckless Operation				
<input type="checkbox"/> Capsizing	<input type="checkbox"/> Fall Overboard	<input type="checkbox"/> Improper Lookout	<input type="checkbox"/> Hull Failure				
<input type="checkbox"/> Flooding/Swamping	<input type="checkbox"/> Fall in Boat	<input type="checkbox"/> Restricted Vision	<input type="checkbox"/> Machinery Failure				
<input type="checkbox"/> Sinking	<input type="checkbox"/> Person Struck by Boat	<input type="checkbox"/> Overloading	<input type="checkbox"/> Equipment Failure				
<input type="checkbox"/> Fire or Explosion (Fuel)	<input type="checkbox"/> Person Struck by Motor/Propeller	<input type="checkbox"/> Improper Loading	<input type="checkbox"/> Operator Inexperience				
<input type="checkbox"/> Fire or Explosion (Other)	<input type="checkbox"/> Struck Submerged Obj.	<input type="checkbox"/> Hazardous Waters	<input type="checkbox"/> Operator Inattention				
<input type="checkbox"/> Skier Mishap	<input type="checkbox"/> Hit and Run	<input type="checkbox"/> Alcohol Use	<input type="checkbox"/> Congested Waters				
<input type="checkbox"/> Collision with Vessel	<input type="checkbox"/> Other (Specify) _____	<input type="checkbox"/> Drug Use	<input type="checkbox"/> Passenger/Skier Behavior				
<input type="checkbox"/> Collision with Fixed Obj.		<input type="checkbox"/> Failure to Vent	<input type="checkbox"/> Dam/Lock				
		<input type="checkbox"/> Improper Anchoring	<input type="checkbox"/> Lack of or Improper Boat Lights				
		<input type="checkbox"/> Standing/Sitting on Gunwales, Bow, Transom	<input type="checkbox"/> Rules of the Road Infraction				
			<input type="checkbox"/> Sharp Turn				
			<input type="checkbox"/> Ignition of Spilled Fuel/Vapor				
			<input type="checkbox"/> Starting In Gear				
			<input type="checkbox"/> Other (Specify) _____				
OPERATOR							
Operator's Name				Owner's Name (if different from Operator's)			
Address				Address			
City, State, Zip Code		Telephone Number ()		City, State, Zip Code		Telephone Number ()	
Operator's Date of Birth (mo/day/yr)		Operator's Experience		Instruction in Boating Safety		U.S. Power Squadron	
		<input type="checkbox"/> None		<input type="checkbox"/> State Course		<input type="checkbox"/> American Red Cross	
		<input type="checkbox"/> Under 100 Hours		<input type="checkbox"/> USCG Auxiliary			
		<input type="checkbox"/> ? 100 Hours		<input type="checkbox"/> None			
<input type="checkbox"/> Male <input type="checkbox"/> Female							

Enforcement

- ◆ **Law enforcement officers have the right to stop a vessel.**
 - **Who can stop your vessel on federal waters?**
 - **Who can stop your vessel on state waters?**
- ◆ **In your state, what must boaters do if they are signaled to stop?**

Lesson Five

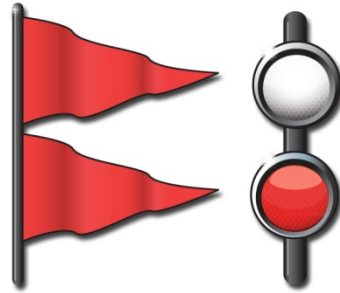

Boating Emergencies...What to Do

Key Topics

- ◆ Risk Management
- ◆ Boating Accidents
- ◆ Personal Injuries
- ◆ Weather Emergencies
- ◆ Summoning Help

Objectives

You should be able to...

- ◆ Explain how to practice risk management while boating.
- ◆ Describe the effects of boating stressors.
- ◆ Explain how dehydration occurs and how to recognize and prevent it.
- ◆ Explain the increased effects of alcohol on the body when on the water.

Objectives

- ◆ Find the personal flotation device (PFD) that is the proper size for the wearer and check a PFD's condition.
- ◆ Explain how to handle situations involving capsizing, swamping, or falling overboard.
- ◆ Avoid collisions.
- ◆ Respond properly to a fire emergency.
- ◆ Take the proper steps if a vessel runs aground.

Objectives

- ◆ **Explain the danger and stages of cold water immersion and what to do to survive.**
- ◆ **Recognize the symptoms of carbon monoxide poisoning and explain how to prevent it.**
- ◆ **Obtain weather forecasts, recognize weather warnings, and explain what to do if caught in severe weather.**
- ◆ **Summon help quickly if a serious boating emergency occurs.**

Risk Management

Profile of a Typical U.S. Boating Fatality

- ◆ PFDs are on board but not in use
- ◆ Vessel is small boat of open design
- ◆ $\frac{1}{3}$ of time alcohol is involved
- ◆ Daylight, good weather
- ◆ Operator is male, 26 to 50, with boating experience
- ◆ **Nearly all accidents are preventable**

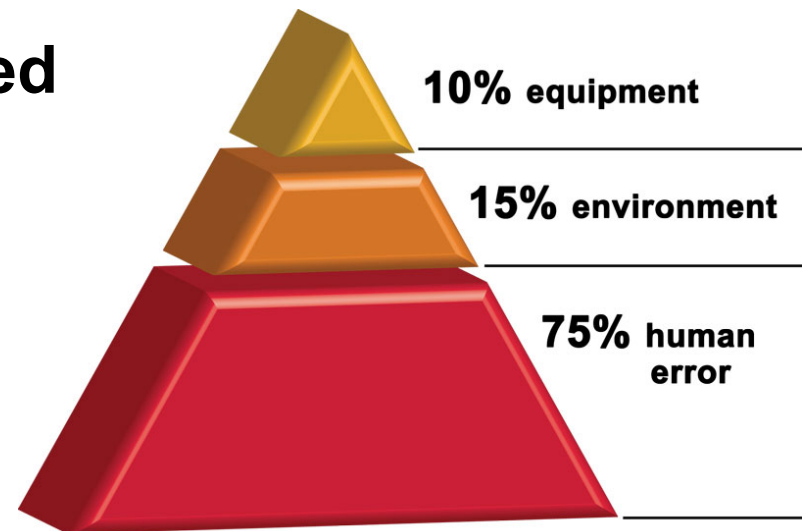

Risk Management

◆ Risk management is:

- **Recognizing dangerous situations and reducing chance that they will happen.**
- **Lessening effects of accidents if they do happen.**

Risk Management

Increased Risk Due to Boating Stressors

- ◆ **Stressors such as sun's glare and heat, motion, and engine noise and vibration increase the risk of a boating accident.**
- ◆ **Stressors weaken your body and mind enough to make the risk of an accident greater.**

Risk Management

Increased Risk Due to Dehydration

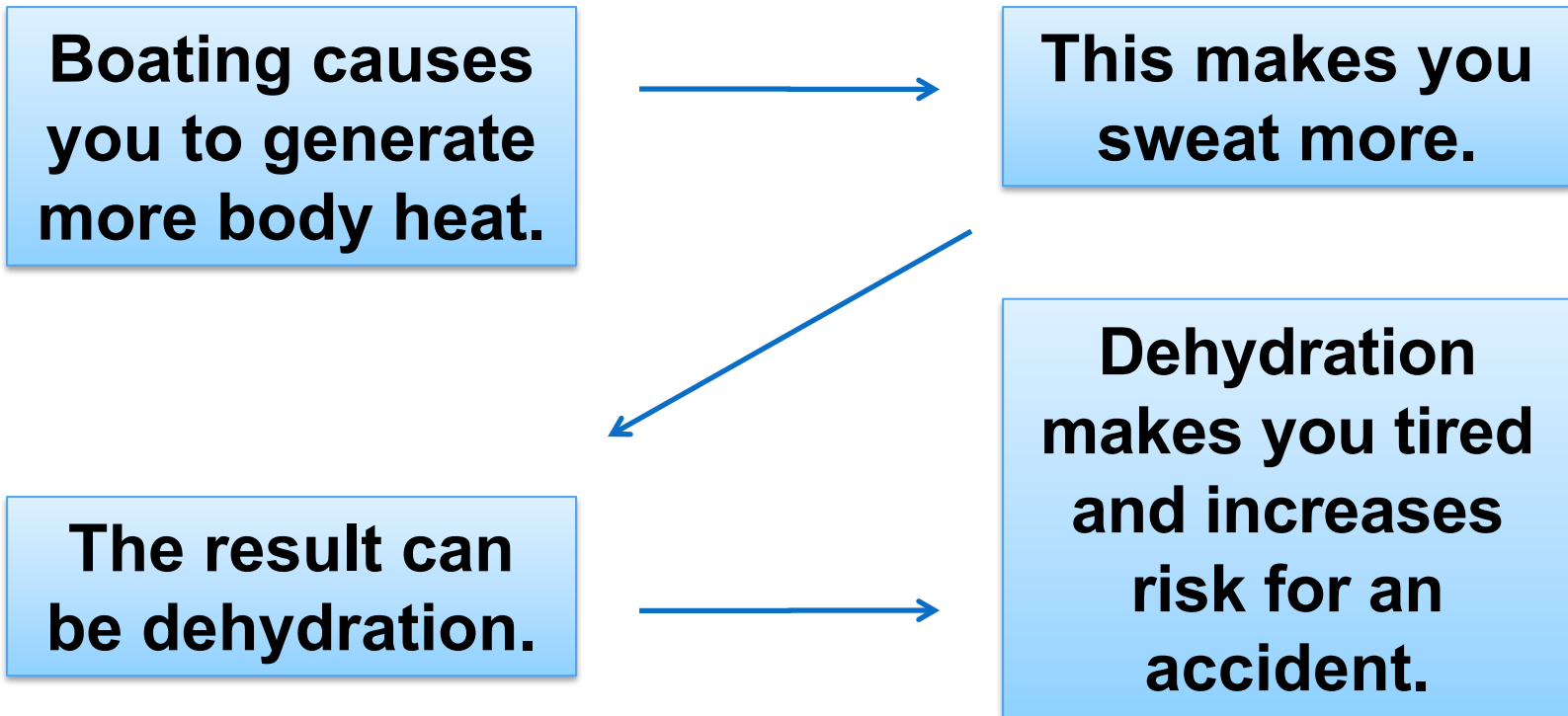

Risk Management

Increased Risk Due to Dehydration

- ◆ To prevent dehydration, drink some water every 15–20 minutes.
- ◆ If dehydration occurs, drink plenty of water and get out of the sun.



Risk Management

Avoiding Alcohol

- ◆ Alcohol increases natural stressors.
- ◆ It takes less alcohol to make a person legally intoxicated on water.

Blood Alcohol Concentration (BAC)

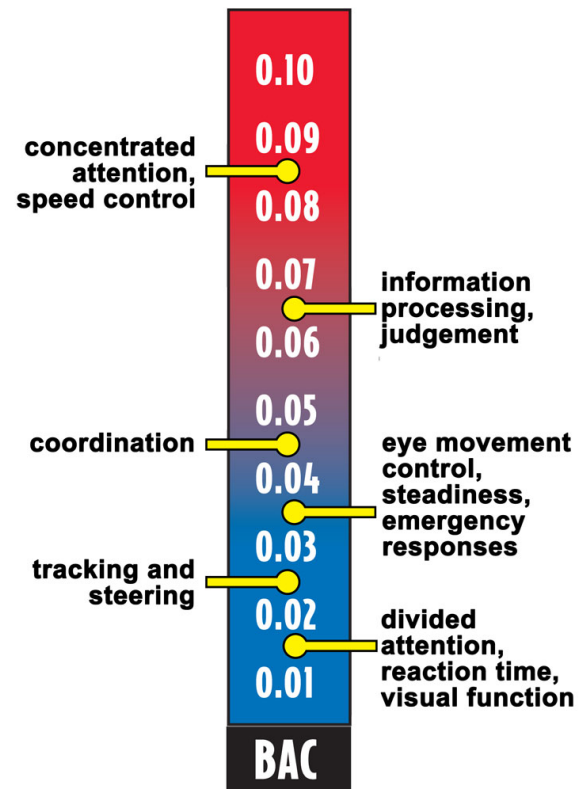

Risk Management

- ◆ **Drinking while boating increases likelihood of accidents.**
 - **Make sure everyone wears a PFD.**
 - **Designate non-drinking boaters to operate the vessel.**

Risk Management

To minimize the risk of an accident—**Don't drink and boat!**



Risk Management

Minimize Risk of Drownings—Wear PFDs

- ◆ Have everyone on board wear a PFD.
- ◆ Follow the requirements:
 - Readily accessible
 - Proper size
 - Good and serviceable condition



Minimize Risk of Drowning

Inflatable PFDs

- ◆ Come in two styles.
- ◆ Inflate if wearer falls into the water.
- ◆ Are approved for 16 or older.
- ◆ Come with operating instructions.



Rescue Technique: Reach, Throw, Row, and Go

If you are on a dock when someone falls in, you should try to “talk” the victim to safety. If he or she is unable to get to the dock, you should:

- ◆ **REACH:** Extend a fishing rod, branch, oar, towel, or other object to REACH out to the victim and pull him or her to safety.



Rescue Technique: Reach, Throw, Row, and Go

- ◆ **THROW:** If the victim is too far away to reach and a boat isn't handy, **THROW** the victim a PFD or anything else that will float.
- ◆ **ROW:** If a rowboat is available, **ROW** to the victim and then use an oar or paddle to pull the victim to the stern.
- ◆ **GO:** Swimmers without lifesaving training should not swim to a victim. Instead, **GO** for help. If you must swim, take along anything that floats to keep between you and the victim.

Boating Accidents

Capsizing, Swamping, or Falling Overboard

- ◆ **Capsizing—boat turns on its side or turns completely over.**

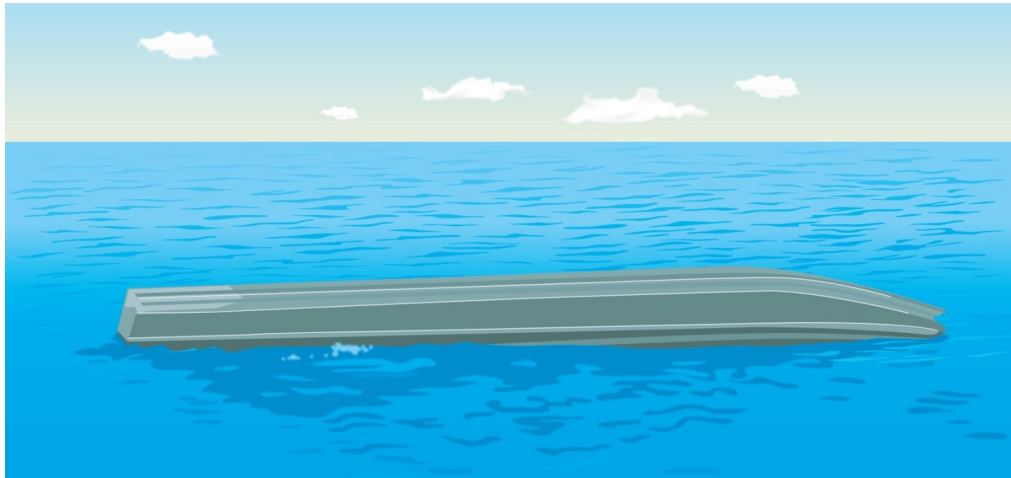

- ◆ **Swamping—boat stays upright and fills with water.**

Boating Accidents

Capsizing, Swamping, or Falling Overboard

◆ For safety:

- Ask everyone to wear a PFD.
- Attach engine cut-off switch lanyard to wrist, clothes, or PFD.
- Don't allow anyone to sit on any area not designed for seating.



Boating Accidents

- **Don't overload your boat.**
- **Keep centered in the boat with your center of gravity low.**
- **Don't let anyone lean a shoulder beyond gunwale in a small boat.**
- **Slow down when turning.**
- **Don't boat in rough water or bad weather.**
- **Secure anchor line to the bow.**

Boating Accidents

- ◆ **If you capsize or swamp your boat or fall overboard:**
 - **Stay with the boat.**
 - **Put a PFD on. Have your passengers do the same.**
 - **Take a head count.**
 - **Signal for help.**

Boating Accidents

- **If your boat is still floating, try to reboard or climb onto it.**

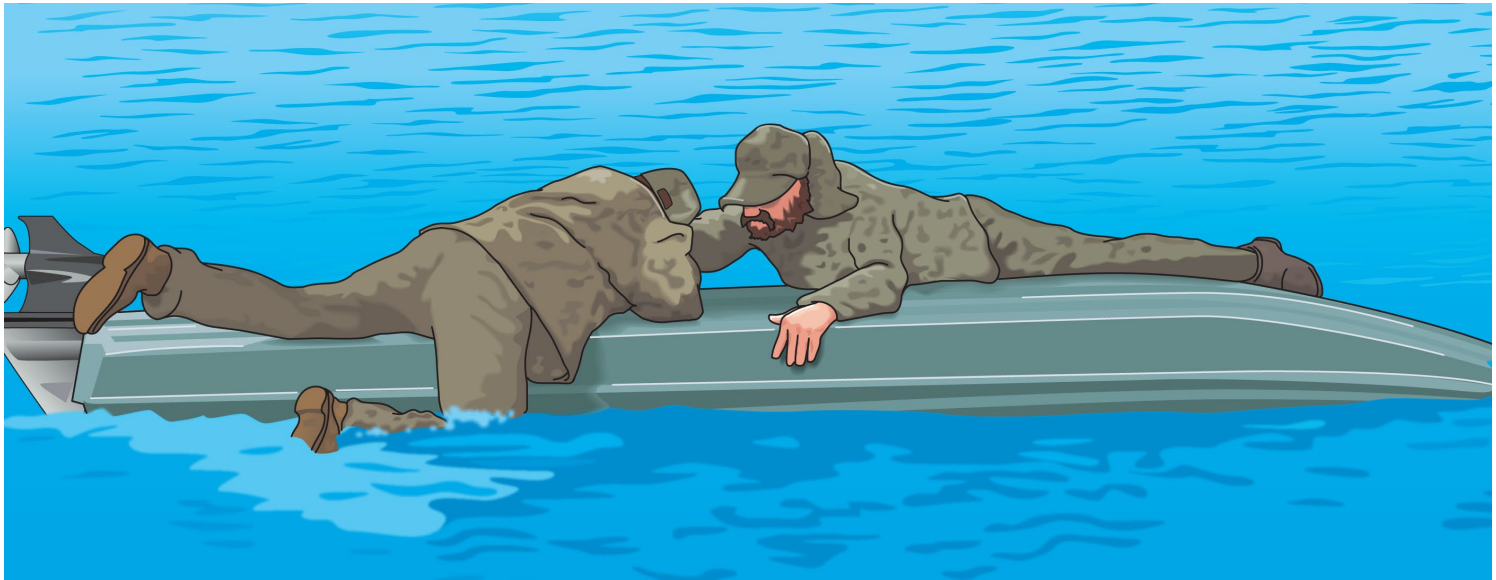

- **If your boat sinks or floats away, look for other items to help support you.**

Boating Accidents

◆ If boat sinks or floats away:

- Don't panic—remain calm and wait for help.
- Make sure your PFD is securely fastened, or find something to help you float.

Boating Accidents

◆ If someone falls overboard:

- **Slow down.**
- **Toss the victim a PFD.**
- **Slowly pull alongside the victim.**
- **Stop the engine.**



Boating Accidents

Avoiding Collisions

- ◆ Follow the rules of navigation.
- ◆ Pay attention to navigation aids.
- ◆ Keep a sharp watch and appoint a lookout.
- ◆ Maintain a safe speed.

Boating Accidents

- ◆ **Look in all directions before turning.**
- ◆ **Use caution when traveling into the sun's glare.**
- ◆ **Never operate when fatigued or stressed, or while consuming alcohol.**
- ◆ **Watch for floating debris.**

Boating Accidents

Dealing With Fire Emergencies

◆ To prevent a fire:

- Don't mix fuel, oxygen, and heat.
- Make sure ventilation systems are working.
- Maintain the fuel system.
- Use safe fueling procedures.

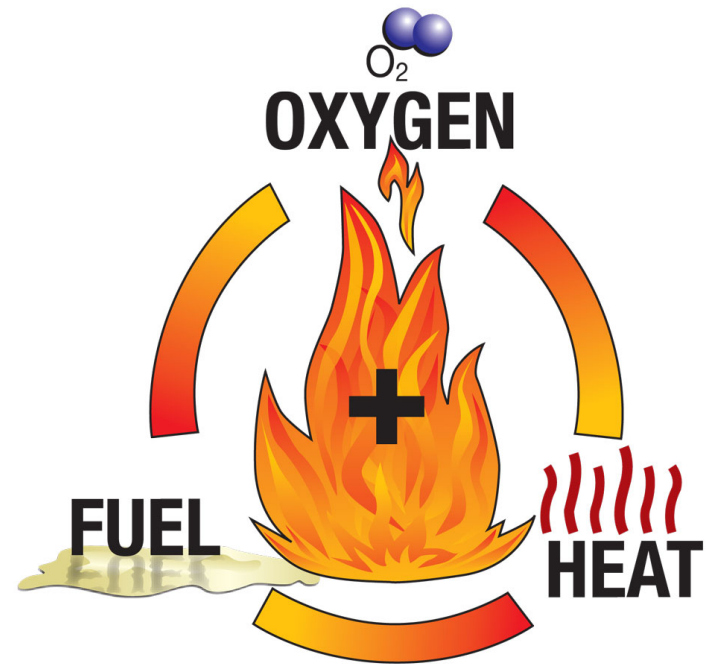

Boating Accidents

◆ If a fire starts:

- Stop the boat.
- Position the fire downwind.
- Shut off fuel supply, if fire is in the engine.
- Use the fire extinguisher (remember PASS).
- Summon help.

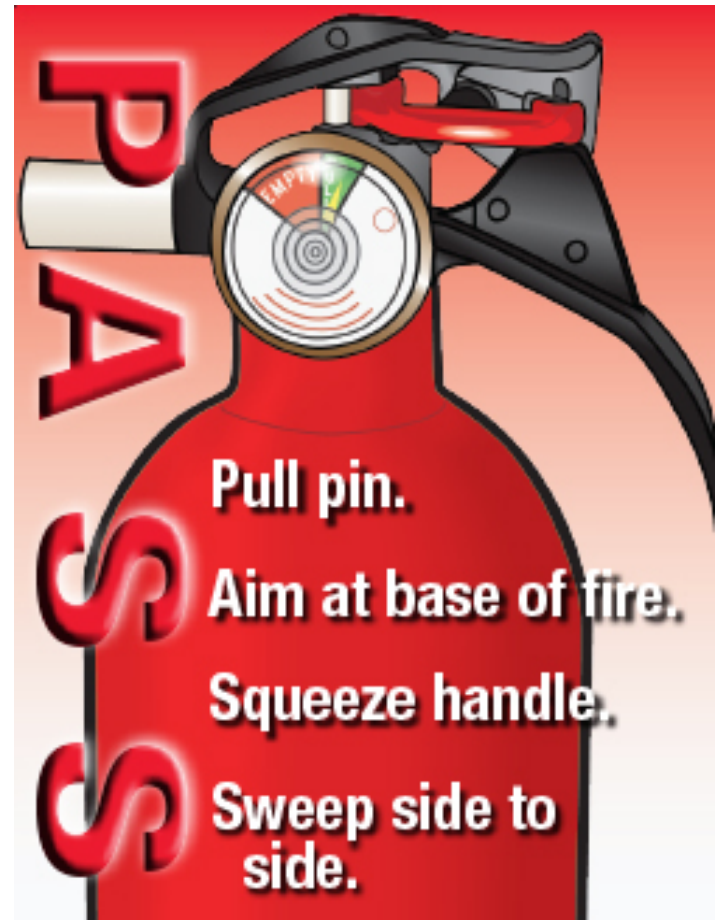

Boating Accidents

Running Aground

◆ To prevent:

- Know your boating environment.
- Find out the location of shallow water and submerged objects.
- Learn to read nautical charts.

Boating Accidents

- ◆ If you run aground:
 - Make sure no one is injured.
 - Check for leaks.
 - Try to get loose.
 - Signal for help if needed.



Personal Injuries

Cold Water Immersion and Hypothermia

- ◆ Kill in several ways.
- ◆ Can cause a reaction in water as warm as 77°F.
- ◆ Understand how your body reacts to cold water to respond appropriately and increase your chance of survival.

Cold Water Immersion

Stages of Cold Water Immersion

◆ Stage 1

- Initial “cold shock”
- Occurs first 3–5 minutes

◆ Stage 2

- Short-term “swim failure”
- Occurs 3–30 minutes following immersion

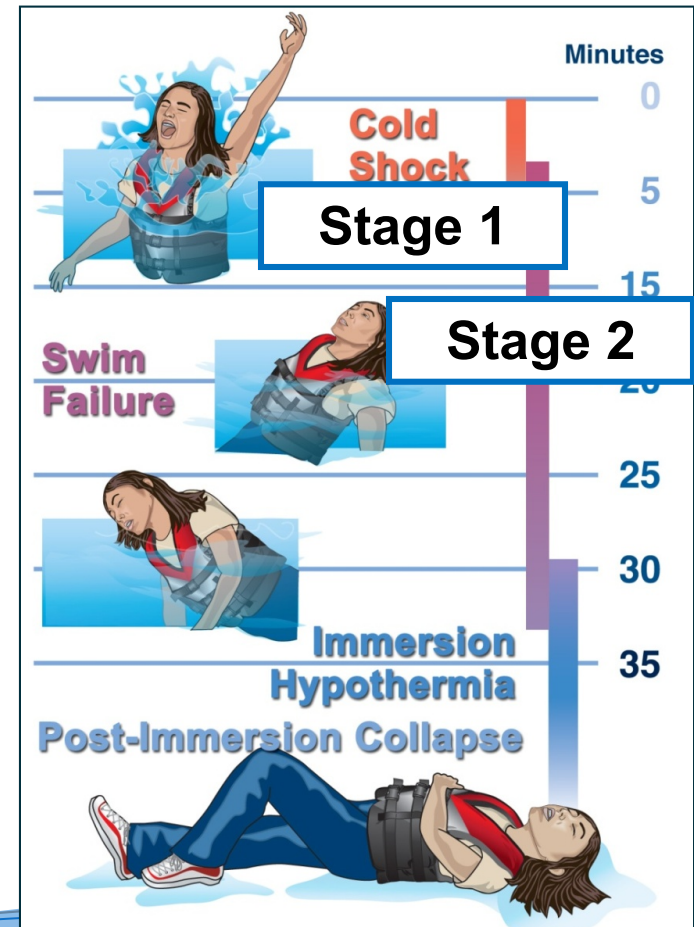

Cold Water Immersion

◆ Stage 3

- Long-term immersion hypothermia
- Sets in after 30 minutes

◆ Stage 4

- Post-immersion collapse
- Occurs during or after rescue

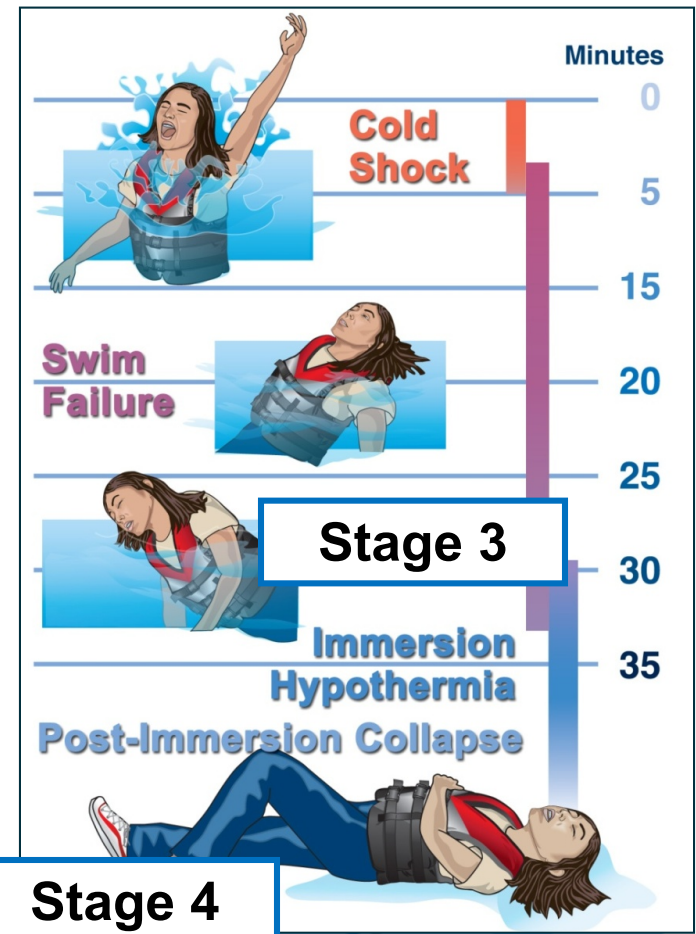

Personal Injuries

Cold Water Immersion and Hypothermia

◆ Survival depends on:

- Keeping your head above water
- Controlling your breathing
- Having timely rescue by yourself or others
- Retaining body heat

Personal Injuries

- ◆ **When boating in cold water conditions:**
 - **Always wear a secured PFD.**
 - **Wear layered clothing.**
 - **Equip your boat with a means for re-entry.**



Personal Injuries

- ◆ **Try to avoid capsizing or falling overboard.**
- ◆ **If you do fall into cold water:**
 - **Don't panic.**
 - **Put on a PFD.**
 - **Do not take off your clothes.**
 - **Try to reboard your boat.**
 - **Stay as still as possible.**
 - **Adopt a position to prevent heat loss.**
 - **Send out emergency distress signals.**

Personal Injuries

Reducing Heat Loss in Cold Water

H.E.L.P.



If alone

Huddle



With others

Personal Injuries

- ◆ **When treating victims of cold water immersion:**
 - **Get the victim out of the water quickly and gently.**
 - **Prevent further heat loss.**
 - **Be prepared to provide basic life support.**
 - **Seek medical help immediately.**

Personal Injuries

Carbon Monoxide Poisoning

- ◆ **Carbon monoxide (CO) is an invisible, odorless, tasteless gas.**
- ◆ **Symptoms of CO poisoning:**
 - **Irritated eyes**
 - **Headache**
 - **Nausea**
 - **Weakness**
 - **Dizziness**

Personal Injuries

◆ To prevent carbon monoxide poisoning:

- Allow fresh air to circulate.
- Keep away from engine and generator exhaust outlets.
- Never sit on the back deck, “teak surf,” or hang on the swim platform.
- Ventilate immediately if you detect fumes.
- Install marine-rated CO detectors.

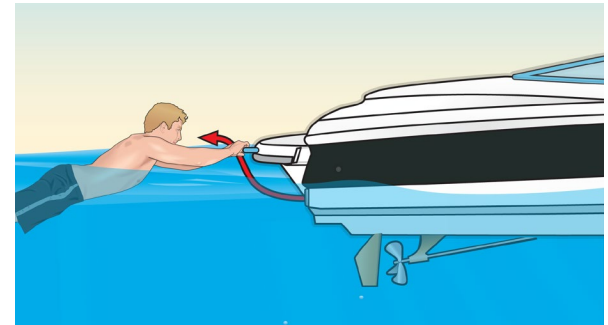

Personal Injuries

- ◆ Never enter areas under swim platforms as air in these areas could be fatal if breathed in.

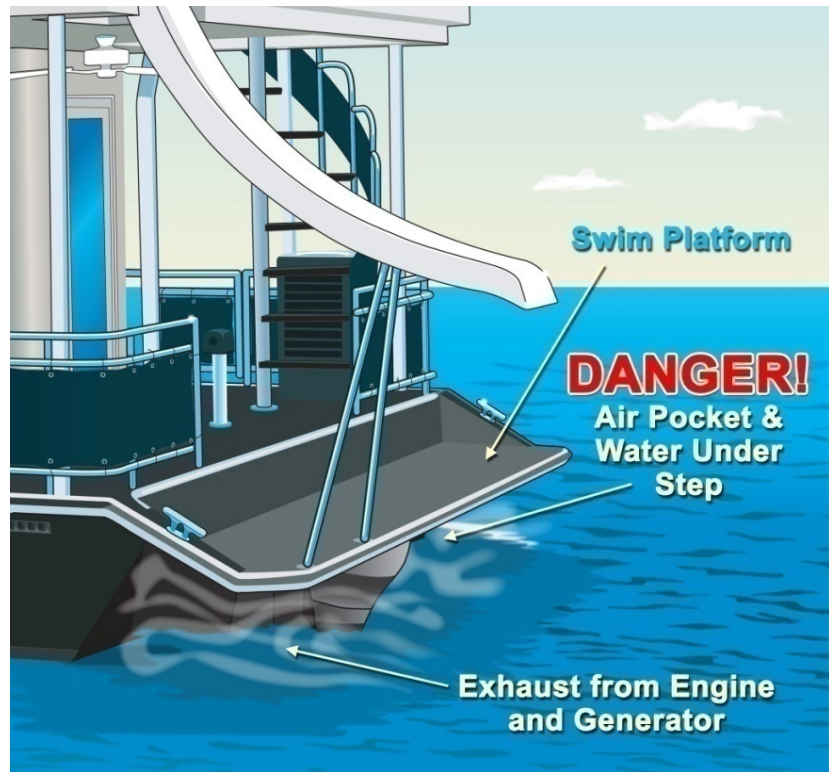

Personal Injuries

- ◆ **Before each boating trip:**
 - **Know the location of exhaust outlets.**
 - **Educate passengers about CO poisoning.**
 - **Check operation of exhaust outlets.**
 - **Listen for any change in exhaust sound.**
 - **Test each CO detector.**

Personal Injuries

◆ Monthly:

- **Make sure exhaust clamps are secure.**
- **Look for leaks in the exhaust system.**
- **Inspect rubber hoses for damage.**

◆ Annually:

- **Have a qualified technician check the engine and exhaust system.**

Personal Injuries

Responding to Other Serious Injuries

- ◆ Shock
- ◆ Bleeding
- ◆ Burns
- ◆ Broken Bones
- ◆ Head, Neck, or Spinal Injury



Weather Emergencies

How to Avoid Severe Weather

- ◆ Tune a radio to a station with weather updates.
- ◆ Be alert to weather conditions.
- ◆ Track changes in barometer readings.
- ◆ Watch for wind shifts, lightning, and rough water.

Weather Emergencies

- ◆ **Be aware of weather to the west.**
- ◆ **Watch for fog.**
- ◆ **Head toward nearest safe shore.**

Weather Emergencies

What to Do if Out in Severe Weather

◆ Prepare the boat.

- Slow down.
- Close hatches, windows, and doors.
- Stow unnecessary gear.
- Turn on all navigation lights.
- Keep bilges free of water.
- Disconnect electrical equipment if there is lightning.

Weather Emergencies

- ◆ **Prepare your passengers for severe weather.**
 - **Make sure everyone is wearing a PFD.**
 - **Have passengers sit on floor close to centerline.**
- ◆ **Decide whether to go to shore or ride out the storm.**
 - **Head for nearest safe shoreline.**
 - **Steer bow of boat into waves.**
 - **Keep sharp lookout for other vessels or hazards.**
 - **If engine stops, drop an anchor.**

Summoning Help

◆ Useful items:

- Visual distress signals
- VHF marine radio
- Mobile phone
- Emergency Position-Indicating Radio Beacon (EPIRB)
- Personal Locator Beacon (PLB)

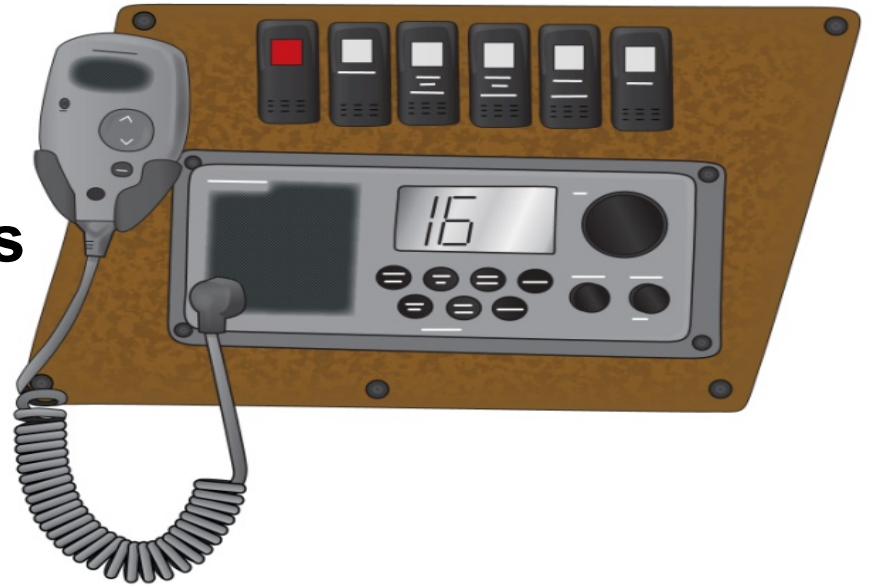

Lesson Six



Enjoying Water Sports With Your Boat

Key Topics

- ◆ **Responsibilities of a Vessel Operator**
- ◆ **Small Boats and Paddlecraft**
- ◆ **Water-Skiing**
- ◆ **Scuba Diving and Snorkeling**
- ◆ **Windsurfing and Sailing**
- ◆ **Fishing and Hunting**

Objectives

You should be able to...

- ◆ Explain a vessel operator's responsibility to his or her passengers.
- ◆ Explain a vessel owner's responsibility when allowing others to use his or her vessel.
- ◆ Explain the boater's responsibility to the environment.

Objectives

- ◆ **Explain a vessel operator's responsibility to others using the waterways.**
- ◆ **List the safety guidelines for small boat operators.**
- ◆ **Properly tow skiers and recognize skier hand signals.**
- ◆ **Explain how to fish or hunt safely from a boat.**

Responsibilities of a Vessel Operator

Responsibility to Your Passengers

◆ Pre-Departure Checklist

- ✓ Check the weather forecast.
- ✓ Check the steering and throttle controls.
- ✓ Check all lights.
- ✓ Check for any fuel or oil leaks.
- ✓ Check hose connections and clamps.
- ✓ Drain all water from the engine compartment.

Responsibilities of a Vessel Operator

- ✓ **Be sure the bilge plug is replaced and secure.**
- ✓ **Make sure you have enough fuel.**
- ✓ **Make sure your engine battery and fire extinguishers are fully charged.**
- ✓ **Attach the engine cut-off switch and lanyard.**
- ✓ **Make sure you have the required number of personal flotation devices (PFDs).**
- ✓ **Leave a float plan.**

Responsibilities of a Vessel Operator

- ◆ **Before casting off, discuss safety.**
 - **Where is the emergency equipment?**
 - **Who needs a PFD?**
 - **What are the laws for:**
 - **Reckless operation?**
 - **Required equipment?**
 - **Waste disposal?**

Responsibilities of a Vessel Operator

Conducting Emergency Drills

◆ Do you know what to do:

- In case of a fire?
- If someone falls overboard?
- In case of a storm?

◆ How do you:

- Signal for help or make a MAYDAY call?
- Anchor the vessel and handle lines (ropes)?

Responsibilities of a Vessel Operator

Responsibility to Others You Allow to Operate Your Vessel

- ◆ **Before allowing others to operate your vessel, make sure they:**
 - **Meet the minimum age and boater education requirements.**
 - **Know basic boating safety and navigation rules.**

Responsibilities of a Vessel Operator

- **Know how to use lanyard with the engine cut-off switch.**
- **Understand the importance of speed restrictions.**
- **Understand the need to keep a proper lookout.**

Responsibilities of a Vessel Operator

- ◆ Before allowing others to drive your PWC, make sure they:
 - Meet the minimum age and boater education requirements.
 - Know they have the same responsibilities as any other vessel operator.



Responsibilities of a Vessel Operator

- **Take their first rides in an uncrowded area.**
- **Know how to steer and control the personal watercraft (PWC).**
- **Know to check carefully before turning.**

Responsibilities of a Vessel Operator

Responsibility to the Environment

- ◆ Keep waters clean and disease-free by disposing of waste and litter properly.
- ◆ Practice the three “Rs”— Reduce, Reuse, and Recycle.
- ◆ Reduce throttle to “no wake” speed when close to a shoreline.
- ◆ Don’t use toxic substances on your vessel or around water.



Responsibilities of a Vessel Operator

Responsibility to Others Using the Waterways

- ◆ Stay aware of others in or on the water.

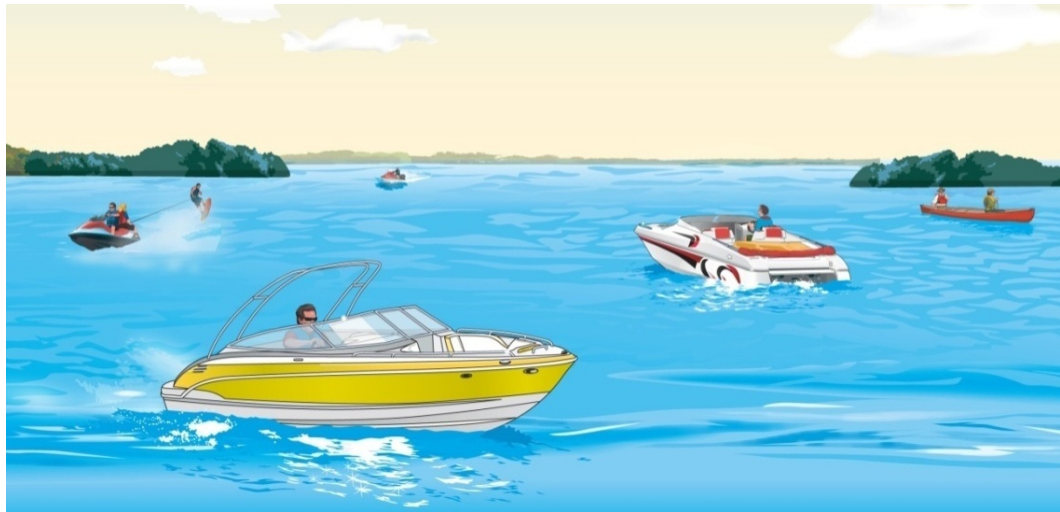

- ◆ Control the noise of your boat or PWC.

Small Boats and Paddlecraft

- ◆ Includes canoes, kayaks, and rafts.
- ◆ To prepare for safety:
 - Always wear a PFD.
 - Never paddle alone.
 - Never overload your craft.
 - Keep low center of gravity.
 - Be alert and aware of surroundings.



Small Boats and Paddlecraft

- **Practice reboarding in water.**
- **Dress properly for the weather.**
- **Check your craft for leaks.**
- **Map a general route and timetable when embarking on a long trip.**
- **Know conditions before you head out.**
- **Watch the weather. Keep close to shore.**

Small Boats and Paddlecraft

◆ Be alert for river hazards:

- Low-head dams**
- Rapids**
- Strainers**

◆ If you capsize:

- Do not try to stand or walk in swift-moving water.**
- Float on your back on the upstream side of your craft.**
- Point your feet downstream.**
- Take precautions to avoid hypothermia.**

Water-Skiing

- ◆ **Before towing a skier, the operator should:**
 - **Have an observer on board.**
 - **Review hand signals with skier.**
 - **Make sure skier is wearing an approved PFD.**
 - **Be familiar with area and any hazards.**
 - **Make sure tow lines are same length for multiple skiers.**
 - **Never tow a skier at night.**

Water-Skiing

- ◆ **While towing a skier, the operator should:**
 - **Start engine after making sure no one is near the propeller.**
 - **Go slowly until ski rope is tight.**
 - **Keep skier at a safe distance from the shoreline.**
 - **Avoid congested areas.**
 - **Watch for other vessels and obstructions.**
 - **Always respond to skier's signals.**

Water-Skiing

- **When a skier falls, circle slowly to return the towline.**
- **If required, display red or orange flag to alert others that skier is down.**
- **Shut off engine before skier reboards.**



Water-Skiing

- ◆ **When in the water, the skier should:**
 - **Wear a PFD.**
 - **Use hand signals.**
 - **Never ski under the influence of drugs or alcohol.**
 - **Never spray swimmers, vessels, or other skiers.**
 - **Never wrap tow rope around your body.**
 - **Hold ski up out of the water after falling.**
 - **Not approach the back of the boat until the engine is off.**

Water-Skiing

Hand Signals for Skiers

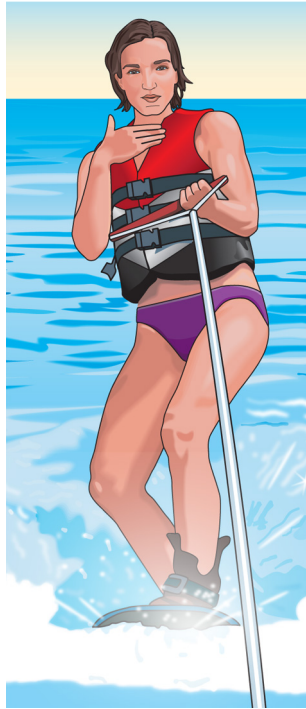

Stop



Skier OK



Skier down

Water-Skiing

Hand Signals for Skiers

Turn left

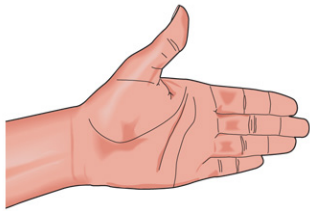

Turn right

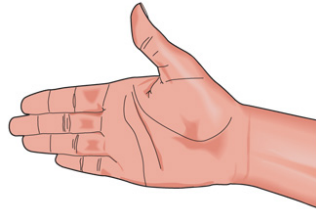

Speed up



Slow down

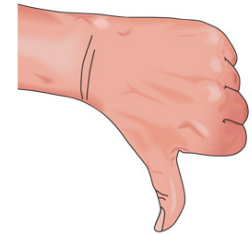

Speed OK



Scuba Diving and Snorkeling

◆ Vessel operators should:

- Be able to recognize a diver-down flag.
- Stay the legal distance away from a flag.
- Look for bubbles.

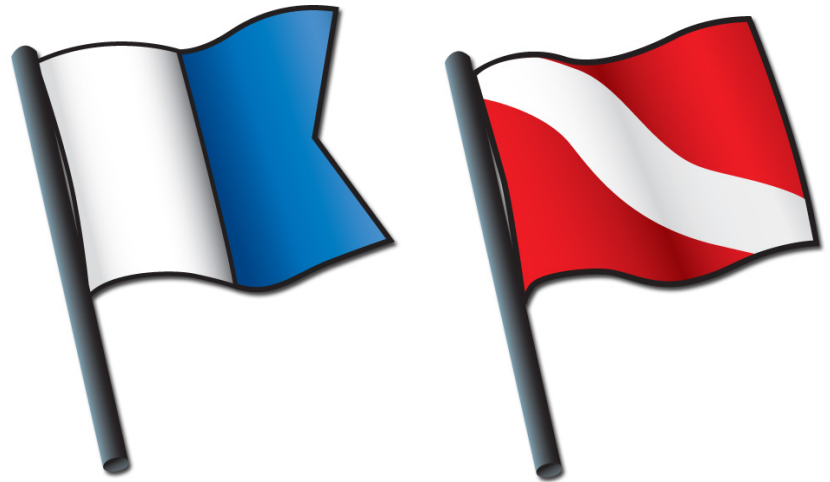

Scuba Diving and Snorkeling

- ◆ **Divers should:**
 - **Display the diver-down flag and stay close to it.**
 - **Select a suitable boat.**
 - **Avoid overloading the vessel.**
 - **Never dive or snorkel alone.**



Windsurfing



- ◆ Dress appropriately.
- ◆ Tell someone your plans.
- ◆ Do not become fatigued.
- ◆ Watch for vessels.
- ◆ Don't go too far from shore.

Sailing

- ◆ **Sailboats are usually the stand-on vessel.**
- ◆ **Small sailboats are prone to capsizing and swamping.**
- ◆ **Falling overboard is common. Always wear a PFD.**
- ◆ **Sailors should always be aware of water temperature.**
- ◆ **A certified sailing course is recommended.**



Sailing

◆ For safety:

- **Stay off water during storms or high winds.**
- **Carry a flashlight.**
- **Make sure sailboats with an engine have red, green, and white navigation lights.**
- **Be aware of mast clearance when passing under power lines and bridges.**

Fishing

- ◆ **Anglers using a vessel to fish should:**
 - **Know and follow all safe boating laws and requirements.**
 - **Not overload the vessel.**
 - **Wear a PFD.**
 - **Recycle or toss used fishing line into receptacles on shore.**
 - **Take care of the fishing boat.**



Fishing

- ◆ **Operators of other vessels should:**
 - **Slow down when approaching fishing boats or give them wide berth.**
 - **Never run over fishing lines.**
 - **Never make a large wake near a fishing boat.**

Hunting

◆ If using a vessel to hunt, you should:

- Obey all boating laws.
- Take extra precautions to avoid capsizing or swamping.
- Wear a PFD at all times.
- Dress in several layers under your PFD on cold water.



Hunting

- Check the weather and stay close to shore.
- Not fire shots or release arrows until vessel is stopped and secured. Remain seated when shooting.
- Take these steps while transporting a firearm:
 - Obey all laws.
 - Keep firearms unloaded with the safety on and in a gun case.

