

BEST PRACTICES FOR SITING SOLAR PHOTOVOLTAICS ON MUNICIPAL SOLID WASTE LANDFILLS



Cover photo: A 2.4 MW DC solar farm was built on top of a landfill located in Rehoboth, MA.
Photo by Lucas Faria / DOE

This document is a joint publication of the U.S. Environmental Protection Agency's Office of Land and Emergency Management and the National Renewable Energy Laboratory (NREL). NREL is a national laboratory of the U.S. Department of Energy, Office of Energy Efficiency and Renewable Energy, operated by the Alliance for Sustainable Energy, LLC. It has been subjected to EPA's peer and administrative review and has been approved for publication as an EPA document.

CONTENTS

List of Figures.....	vi
List of Tables.....	vii
List of Highlights.....	vii
I. Introduction.....	1
1.1 Purpose and Audience for this Document.....	3
1.2 Document Organization.....	5
2. Landfill Overview.....	6
2.1 Background on Federal MSW Landfill Regulations.....	6
2.2 MSW Landfill Design Standards, Operating Requirements and Major System Components.....	7
2.3 Closure and Post-Closure Care.....	8
3. Solar PV Overview.....	10
3.1 How PV Works.....	10
3.2 Major System Components.....	10
3.2.1 PV Module.....	11
3.2.2 Inverter.....	12
3.2.3 Balance-of-System Components.....	13
3.2.4 Batteries.....	16
3.2.5 PV System Monitoring.....	19
3.3 Cost Overview.....	20
3.3.1 Cost Trends and General Rule of Thumb for PV Costing.....	20
3.3.2 Cost per Watt Breakdown.....	20
3.3.3 Operation and Maintenance Cost.....	21
3.4 Typical Solar PV Siting Process.....	22
4. Feasibility Considerations Unique to Landfills.....	23
4.1 General Physical Setting.....	24
4.1.1 Meteorological Setting.....	24
4.1.2 Solar Resource Availability.....	25
4.1.3 Land Use and Ecological Conditions.....	26
4.1.4 Transportation and Electrical Transmission Infrastructure.....	27
4.2 Landfill Technical Siting Considerations.....	27
4.2.1 Acreage of the Site.....	27
4.2.2 Landfill Characteristics.....	27
4.2.3 Institutional Controls.....	32
4.2.4 Long-term Maintenance Requirements.....	33
4.3 PV Technology Selection and Technical Design.....	33
4.3.1 Matching Appropriate PV Technology to Landfill Characteristics.....	33
4.3.2 Conceptual Design of Major System Components.....	34

4.3.3 Energy Prediction	35
4.3.4 Economic Considerations	36
4.3.5 Interconnection	37
4.3.6 Net Metering.....	37
4.3.7 Virtual Net Metering	38
4.4 Community Support.....	39
4.4.1 Community Engagement and Support.....	39
4.4.2 Visual Impacts and Mitigation Strategies	41
5. Design Considerations Unique to Building PV Projects on Landfills	42
5.1 Landfill Characteristics.....	42
5.1.1 Landfill Slope, Slope Orientation and Cap Characteristics	42
5.1.2 Settlement Potential	44
5.1.3 Other Landfill Systems	45
5.2 PV Technology Selection and Design Considerations.....	45
5.2.1 Anchoring Systems.....	45
5.2.2 Fixed Tilt Mounting Systems.....	47
5.2.3 Modules	48
5.2.4 Other Technologies.....	49
5.3 Integrated Landfill-PV System Design Considerations	51
5.3.1 System Weight and Dynamic Load Considerations.....	51
5.3.2 Lightning Protection and Grounding.....	53
5.3.3 Cover Management.....	54
5.3.4 Stormwater Management.....	54
5.3.5 Integration with Landfill Gas Monitoring and Production Systems.....	55
5.3.6 Site Security.....	56
5.4 Final PV System Engineering Design and Layout	56
6. Construction Considerations Unique to Building PV Projects on Landfills	57
6.1 Site Preparation and Grading Considerations	57
6.2 Penetrations of the Landfill Cap.....	58
6.3 Avoidance of Landfill Gas Monitoring, Piping and Production Equipment.....	58
6.4 Dust Control	58
6.5 Stormwater Management.....	59
6.6 Site Security.....	59
7. O&M Considerations for PV Projects on Landfills.....	60
7.1 Adherence with Landfill Post-Closure O&M and Monitoring Plans.....	60
7.2 Panel Washing and Water Management Plan or Natural Cleansing	60
7.3 Stormwater Management.....	61
7.4 Vegetation and Cover Management.....	61

7.5 System Monitoring and Troubleshooting.....	61
7.6 System Security	62
8. A Summary of Best Practices for Siting Solar PV Projects on Landfills	63
Appendix A: Solar PV on Landfill Projects	67
Appendix B: Tools and Resources	69
EPA’s RE-Powering America’s Land Initiative, Renewable Energy Interactive Mapping Tool.....	69
Siting Renewable Energy on Contaminated Properties: Addressing Liability Concerns Fact Sheet	70
NREL System Advisor Model.....	70
NREL PVWatts.....	72
Solar Decision Tree	73
Hydrologic Evaluation of Landfill Performance (HELP) Model.....	74
Appendix C: Financing and Procurement Options	76
Owner and Operator Financing (Direct Ownership).....	76
Third Party Developers with PPAs	76
Third Party “Flip” Agreements	76
Hybrid Financial Structures	77
Solar Services Agreement and Operating Lease	77
Sale/Lease Back.....	77
Community Solar	77
Appendix D: References.....	79

LIST OF FIGURES

Figure 2-1: Cross-section of a MSW landfill.....	8
Figure 3-1: Generation of electricity from a PV cell.....	10
Figure 3-2: Ground mount array diagram.....	10
Figure 3-3: Mono- and multi-crystalline solar modules.....	11
Figure 3-4: Thin-film solar modules installed on (i) solar energy cover and (ii/iii) fixed tilt mounting systems.....	12
Figure 3-5: Schematic of PV system with various inverter system.....	13
Figure 3-6: 2-Megawatt peak (MWp) PV system with fixed tilt on former landfill in Fort Carson, Colorado.....	14
Figure 3-7: PV system with single-axis trackers installed on former landfill at Nellis Air Force Base, Nevada.....	15
Figure 3-8: PV system with dual-axis trackers.....	15
Figure 3-9: PV plus storage system configurations.....	17
Figure 3-10: A representative figure of a PV system monitoring dashboard.....	19
Figure 3-11: PV system cost benchmark summary (inflation-adjusted) from 2010 to 2020.....	20
Figure 3-12: Utility-scale PV system cost breakdown.....	21
Figure 3-13: Q1 2020 residential, commercial and utility-scale O&M costs by category.....	21
Figure 3-14: Renewable energy project development process.....	22
Figure 4-1: U.S. PV solar resource (kWh/m ² /day).....	26
Figure 4-2: Schematic of possible cover system components.....	30
Figure 4-3: Sample solar PV and landfill integrated system design.....	34
Figure 4-4: Interconnection review process.....	37
Figure 4-5: Net metering schematic for a residential PV system.....	38
Figure 5-1: Ballasted anchoring system at Landfill IA project at New Jersey Meadowlands.....	46
Figure 5-2: Precast ballast foundation for fixed tilt PV on a landfill.....	46
Figure 5-3: Slab foundation for PV system at Boulder, Colorado.....	47
Figure 5-4: Hickory Ridge Road Landfill – geomembrane solar cover.....	50
Figure 5-5: Basic wind speed map.....	52
Figure 5-6: Snow loading on solar panels.....	53
Figure 5-7: Lightning protection.....	53
Figure 7-1: Examples of remote PV system monitoring approaches.....	61
Figure A-1: Annual growth in solar installations on landfill/landfill buffer.....	67
Figure B-1: RE-Powering Mapper application.....	69
Figure B-2: SAM block diagram.....	70
Figure B-3: Generic SAM interface.....	71
Figure B-4: Sample output from SAM simulation.....	72
Figure B-5: Example of input and output of PVWatts.....	72
Figure B-6: The Electronic Decision Tree uses a series of yes/no/skip questions.....	73

Figure B-7: Supplemental information screen	74
Figure B-8: HELP model screen	74

LIST OF TABLES

Table 4-1: Average Land use by System Type for Solar PV installations	36
Table 5-1: Inter-relationships Between Landfill Cap Characteristics and PV System Design	43
Table 8-1: Summary of Technical Considerations, Challenges and Best Practices	63
Table A-1: Selected Completed Solar Landfill Projects	68

LIST OF HIGHLIGHTS

Highlight 1-1: RE-Powering and Environmental Justice	2
Highlight 1-2: Turning a Liability into an Asset	4
Highlight 2-1: Trends in MSW Landfill Ownership	6
Highlight 3-1: Microgrid and Battery Storage Explored	17
Highlight 4-1: Community Engagement Best Practices	39
Highlight 4-2: Staying Dynamic and Relevant in the Changing World	40
Highlight 5-1: Major Considerations Impacting Solar PV Project Design on Landfills	42
Highlight 5-2: Capping Explored	44
Highlight 5-3: Integrated Geomembranes	50
Highlight 6-1: Major Construction Considerations for Building PV Projects on Landfills	57
Highlight 7-1: Major Construction Considerations and Best Practices	60

I. INTRODUCTION

Have you ever wondered how to turn an idle landfill into a source of income and clean energy for your community? With property prices fluctuating and local governments creating renewable energy goals,¹ many communities are looking for suitable land to site renewable energy. Most municipalities have landfills, and these landfills are oftentimes idle and not suitable for other types of redevelopment. This document explores the opportunities and identifies best practices for evaluating landfills for reuse as renewable energy producers.

Returning formerly contaminated lands, landfills and mine sites to reuse helps to achieve U.S. Environmental Protection Agency (EPA)'s goal of restoring underutilized and contaminated properties to environmental and economic vitality. Although the final decision on how stakeholders will reuse a property is inherently a local decision that often rests with the property owner, EPA supports and encourages revitalization as part of the cleanup of contaminated properties across all of its cleanup programs. Reuse of landfills has many positive effects that apply to a variety of stakeholders as noted below.

The objectives of reuse and those of landfill closure are best accomplished if they are carefully coordinated. To this end, the purpose of this document is to assist municipalities, developers, communities and other stakeholders to better understand, coordinate and carry out solar installations on municipal solid waste (MSW) landfills.

Through the RE-Powering America's Lands Initiative, EPA promotes and encourages the reuse of potentially contaminated properties, landfills and mining sites for renewable energy generation when such development is aligned with the community's vision for the site.² EPA has identified several possible benefits for siting solar photovoltaics (PV) facilities on MSW landfills, noting that these sites:³

- May provide an economically viable reuse for sites that may have low real estate development demand.
- May have environmental conditions that are not well suited for commercial or residential redevelopment.
- Can be developed in place of limited open space, preserving the land as a carbon sink and/or for other ecosystem services.
- Generally, are located near existing roads and energy transmission or distribution infrastructure.
- May be adequately zoned for renewable energy.
- Can provide job opportunities in urban and rural communities.
- Can advance cleaner and more cost-effective energy technologies.
- May reduce the environmental impacts of energy systems (e.g., reduce greenhouse gas emissions).

EPA has screened more than 190,000 formerly contaminated lands, landfills and mine sites (EPA 2022c)—covering nearly 44 million acres across the United States—for suitability as locations for renewable energy generation facilities, including utility-scale solar. These sites are included in EPA's RE-Powering Mapper.⁴ The RE-Powering Mapper locates and provides information about these sites and their potential for supporting renewable energy generation. The application enables users to view screening results for various renewable energy technologies at each site.

RE-Powering America's Lands Initiative tracks benefits of renewable energy installations on contaminated lands, landfills and mine sites in the RE-Powering Benefits Matrix (EPA 2022a). Common benefits reported include revenue from land leases and taxes, electricity cost savings associated with the reduced need to purchase power from the grid, job creation and reduced greenhouse gas emissions.

¹ See, for example, U.S. Conference of Mayors (2018)

² For more information on the RE-Powering America's Lands Initiative, see epa.gov/re-powering.

³ For more information about the benefits associated with the benefits of reuse of potentially contaminated properties, landfills and mining sites for renewable energy generation, see epa.gov/re-powering/what-re-powering#benefits.

⁴ For access to the RE-Powering Mapper, see epa.gov/re-powering/how-identify-sites#looking.

Stakeholders involved with site re-development report many types of benefits including job creation, energy cost savings, revenue, jobs and environmental benefits. For communities with environmental justice concerns, solar projects on landfills can turn community liabilities into community assets and help address environmental injustices. For example, project planning can include improving energy justice outcomes to benefit the residents near the landfill by providing low-cost electricity and job training opportunities. Here are some examples:

Highlight I-I: RE-Powering and Environmental Justice

Communities near contaminated sites are typically overburdened and underserved, creating environmental justice concerns. “Approximately 60 percent of the sites to receive funding for new cleanup projects are in historically underserved communities” (EPA 2021a). For example, more than 1 in 4 Black and Hispanic Americans live within three miles of a Superfund site, a higher share than the overall population, and thousands of these contaminated sites exist nationally. EPA is investing \$1 billion to initiate cleanup and clear the backlog of 49 previously unfunded Superfund sites and advance progress at dozens of other sites. This includes one that received ash, cinders, demolition debris and other wastes from 1919 to the mid-1970s.⁵

Renewable energy development offers many advantages to communities interested in finding a beneficial reuse for contaminated sites. The benefits from placing renewable energy on contaminated lands are numerous and range from revenue generated to environmental protection benefits.

The RE-Powering Initiative seeks to encourage renewable energy development on these underutilized lands in communities with environmental justice concerns. This can be achieved by providing best practices (like this document), [data](#), [tools](#), [case studies](#), [examples of benefits](#) and [outreach resources](#) to encourage renewable energy development on contaminated lands, landfills and mining sites. See the below examples of landfills benefiting underserved communities.⁶

DELANCO LANDFILL COMMUNITY SOLAR, DELANCO, NEW JERSEY

The Delanco Landfill Community Solar project was completed in 2021 and will provide energy to more than 700 subscribers in Public Service Enterprise Group (PSEG) territories. The 3.1 MW project will support 51% low- to moderate-income residents, who will receive guaranteed savings on their electric bills for 20 years with no cancellation fees and save an estimated \$120 annually. The solar project has created more than 35 local jobs. (Soltage 2021)

NORWOOD LANDFILL COMMUNITY SOLAR, NORWOOD, COLORADO

The rural electric cooperative San Miguel Power Association partnered with GRID Alternatives to develop this 0.2-MW community solar array that will [reduce energy costs](#) for 30-40 income-qualified households. Subscriptions of up to 2 kW of generation per household are free of charge to qualified applicants and allow access for five years, after which residents may reapply.⁷

COYOTE RIDGE LANDFILL SOLAR, FORT COLLINS, COLORADO

Located on nine acres of landfill buffer in Fort Collins, CO, this 1.96-MW community solar partnership was planned and developed by electric cooperative Poudre Valley Rural Electric Association and GRID Alternatives. The subscriber model includes [70% of output](#) earmarked for nonprofit and low-income customers. The project also provided more than 1,000 hours of hands-on solar job training during construction.⁸

⁵ See information on the Scovill Industrial Landfill, Waterbury, Connecticut at <https://www.epa.gov/superfund/superfund-sites-new-construction-projects-receive-bipartisan-infrastructure-law-funding>.

⁶ For an example of RE-Powering data, see datasets used in the RE-Powering Mapper, accessible at <https://www.epa.gov/re-powering/how-identify-sites#looking>. For an example of tools, see the RE-Powering Electronic Decision Tree at <https://www.epa.gov/re-powering/re-powerings-electronic-decision-tree>. Successful case studies can be found at <https://www.epa.gov/re-powering/re-powering-how-develop-sites#success>, and benefits are captured in the RE-Powering Benefits Matrix at <https://www.epa.gov/re-powering/re-powering-benefits-matrix>. More information, including training opportunities and informational webinars is available at <https://www.epa.gov/re-powering/re-powering-want-learn-more>.

⁷ For more information on the Norwood Landfill Community Solar project and other income-qualified programs operated by the San Miguel Power Association, see <https://www.smpa.com/content/iq-programs>.

⁸ For information about the Coyote Ridge Landfill Solar project and the Poudre Valley Rural Electric Association's cooperative solar programs, see <https://www.pyrea.coop/mylocalsolar>.

In 1986, before MSW regulations in 40 CFR Part 258 were promulgated, there were an estimated 6,500 operating landfills in the United States (EPA 1988). By 2009, that number had dropped to 1,908 landfills (EPA 2021b). Landfills that closed over the intervening years—plus portions of active landfills with closed cells—represent thousands of acres of real property that may be suitable for siting solar PV. At least one study estimates the area of closed landfills to be hundreds of thousands of acres. As part of the RE-Powering mapping effort, over 18,000 of the country's landfills have been pre-screened for renewable energy potential.

Many MSW landfills are particularly well-suited for solar development because they are often:

- Located near critical infrastructure including electric transmission lines and roads.
- Located near areas with high energy demand (e.g., large population bases).
- Constructed with large areas of minimal grade (0-2 percent) needed for optimal siting of solar PV structures.
- Offered at lower land costs when compared to open space.
- Able to accommodate net metered or utility scale projects.

1.1 PURPOSE AND AUDIENCE FOR THIS DOCUMENT

This document is a joint publication of EPA and the National Renewable Energy Laboratory (NREL). EPA and NREL created this document to provide useful information regarding common technical challenges associated with siting PV on MSW landfills. EPA and NREL expect that landfill owners, consulting engineers, planners and federal, state and local governments may find this information useful when looking for promising locations for PV systems and/or considering whether a specific MSW landfill would be a good candidate for PV. The document is primarily targeted to this audience. Engineers with expertise in landfill engineering, PV design and PV installation should be consulted for more detailed feasibility studies and to guide design and installation of PV systems on MSW landfills.

This document focuses on MSW landfills, including but not limited to those that are regulated under EPA's Resource Conservation and Recovery Act (RCRA) regulations at 40 CFR Part 258. It may be determined on a site-by-site basis if this information is useful for siting PV solar on other types of landfills such as those exempt from 40 CFR Part 258, hazardous waste landfills, industrial waste landfills and construction and demolition (C&D) landfills. MSW landfills are subject to varying regulatory requirements under RCRA and other authorities at the federal, state and/or local level. Therefore, this document does not attempt to apply the best practices discussed to a particular regulatory context, and the strategies discussed may or may not be available at a particular site.⁹

Over time, solar PV on landfills has represented an increasing share of all renewable energy installations on contaminated lands. In 2012, 39 percent of all RE-Powering projects completed were solar on landfill installations. In 2018, 81 percent of RE-Powering projects completed were solar on landfill installation.¹⁰ EPA and NREL, along with our state and local partners, have examined many of these projects and reviewed current designs and approaches in an ongoing effort to identify best practices for siting PV on MSW landfills. The information and case studies contained in this document reflect current engineering and scientific understanding and practices. Project stakeholders should consult engineers with expertise in landfill engineering, PV design and PV installation when considering appropriate practices applicable to specific site conditions.

⁹ This document does not address what activities associated with siting solar PV may be appropriate on landfills subject to cleanup actions taken pursuant to CERCLA and/or RCRA Corrective Action. Further, this document is not intended to discuss CERCLA liability considerations. For more information on EPA's cleanup enforcement programs, see [epa.gov/enforcement/waste-chemical-and-cleanup-enforcement](https://www.epa.gov/enforcement/waste-chemical-and-cleanup-enforcement).

¹⁰ See Appendix A for a list of identified projects (source: RE-Powering Tracking Matrix, [epa.gov/re-powering/re-powering-tracking-matrix](https://www.epa.gov/re-powering/re-powering-tracking-matrix)).

Highlight I-2: Turning a Liability into an Asset

The city of East Providence, RI, had plans to repurpose its former landfill. The landfill closed in 1980 but was never properly capped. Over the years, the city considered several potential options for reuse, but found them to be cost-prohibitive. Several factors helped East Providence move towards solar redevelopment. In 2010, the City's Comprehensive Plan update identified the former landfill site for renewable energy reuse, while the state's passage of solar legislation for distributed generation in 2011 helped provide a viable structure for the sale of solar power. The installation includes 50,000 square feet of fill gravel provided free of charge from the RI Department of Transportation from a nearby highway interchange project, which provided cost savings of about \$1 million.

In collaboration with the RI Department of Environmental Management, the city established a closure plan that allowed for phased capping of the East Providence landfill. This allowed the city to offset the cost of the cap (an estimated \$1.5 million) by developing solar in phases and funding the work based on anticipated revenues from the solar installation. The implementation of Rhode Island's distributed generation policy helped to encourage the use of solar at the East Providence landfill site. The policy provides a financial incentive for renewable energy generation. The incentives vary based on project type and size, and they are guaranteed through approved 20-year term tariffs. Additional support for the project came in the form of funding from the state's Renewable Energy Fund and the federal American Recovery and Reinvestment Act of 2009.

The soil- and compost-based landfill cap on the East Providence landfill can support natural vegetation, which can reduce runoff but does require some maintenance. The solar development team created an integrated operations and maintenance plan that coordinated the monitoring of the landfill cap and the operations of the solar farm. Under the integrated plan, the city maintains liability for the existing conditions of the landfill, while the engineering, procurement and construction contractor will maintain the solar project.

EAST PROVIDENCE AT-A-GLANCE

- Located in East Providence, RI.
- Owned by the city of East Providence.
- Former municipal landfill operating from 1969 to 1979.
- 3.7-MW solar PV installation on approximately 14 acres of a 229-acre site.
- 12,848-panel solar array.
- Solar power used by the city for a wastewater treatment plant and a nearby school.
- City receives revenue from land lease and payment in lieu of taxes.



I.2 DOCUMENT ORGANIZATION

The document is organized into eight major chapters:

- **Chapter 1. Introduction:** Provides a brief overview of the document.
- **Chapter 2. Landfill Overview:** Provides an overview of MSW landfill regulations, typical landfill system components and requirements related to MSW landfill closure and post-closure care and use as context for the remainder of the document.
- **Chapter 3. Solar PV Overview:** Describes the types of PV technology currently sited on landfills, provides a brief overview of typical PV system components, and outlines estimated costs of PV technologies currently sited on landfills, including installation costs.
- **Chapter 4. Feasibility Considerations Unique to Landfills:** Provides information useful for assessing the feasibility of siting PV systems on landfills, with a focus on the unique considerations (e.g., landfill settlement, slope and usable acreage, technology selection) to be considered.
- **Chapter 5. Design Considerations Unique to Building PV Projects on Landfills:** Outlines landfill characteristics to be accounted for when designing a solar project on a landfill, PV system layout and component system designs and special design considerations for an integrated landfill-PV system.
- **Chapter 6. Construction Considerations Unique to Building PV Projects on Landfills:** Discusses site preparation and grading, protection of landfill system components, and other site-specific aspects to be considered before starting construction of a PV system on a landfill.
- **Chapter 7. Operations and Maintenance Considerations for PV Projects on Landfills:** Outlines longer-term actions (e.g., adherence with post-closure plans, water management, module cleaning) to be taken to ensure continued safe and effective operation of the integrated landfill-PV system.
- **Chapter 8. A Summary of Best Practices for Siting Solar PV Projects on Landfills:** Summarizes the best practices for siting solar PV projects on landfills as discussed throughout the document.

This document also contains the following appendices:

- **Appendix A. Solar PV on Landfill Projects**
- **Appendix B. Tools and Resources**
- **Appendix C. Financing and Procurement Options**
- **Appendix D. References**

Disclaimer

This document provides general information and guidance regarding siting solar PV facilities on MSW landfills. It does not address all information, factors or considerations that may be relevant in a particular situation. This document is not legally binding. The word “should” and other similar terms used in this document are intended as general recommendations or suggestions that might be generally applicable or appropriate and should not be taken as providing legal, technical, financial or other advice regarding a specific situation or set of circumstances.

This document describes and summarizes statutory provisions, regulatory requirements and policies. The document is not a substitute for these provisions, regulations or policies, nor is it a regulation itself. In the event of a conflict between the discussion in this document and any statute, regulation or policy, this document would not be controlling and cannot be relied upon to contradict or argue against any EPA position taken administratively or in court. It does not impose legally binding requirements on EPA or the regulated community and might not be applicable in a particular situation based upon the specific circumstances. This document does not modify or supersede any existing EPA guidance document or affect the Agency’s enforcement discretion in any way.

References to third-party publications, websites, commercial products, process or services by trade name, trademark, manufacturer or otherwise, are for informational purposes only. No endorsement or recommendation should be inferred and is not implied. EPA, NREL and the U.S. Government do not endorse any non-federal product, service or enterprise.

2. LANDFILL OVERVIEW

This chapter provides an overview of MSW landfill regulations, common MSW landfill system components and requirements related to MSW landfill closure and post-closure care and use. This information provides context for the remainder of the document and identifies critical regulatory requirements to be considered when assessing feasibility and siting solar technologies on MSW landfills. EPA encourages all parties to fully examine federal, state and local standards before undertaking solar planning and construction activities on a landfill. Overall, PV systems sited at landfills should be integrated with, and designed with careful attention to, these regulatory requirements.

2.1 BACKGROUND ON FEDERAL MSW LANDFILL REGULATIONS

Prior to the 1960s, household and other types of waste were disposed of in open dumps. These facilities were generally constructed with little engineering design or siting criteria and few regulatory controls. In response to the increasing environmental damage created by these dumps, Congress passed the Solid Waste Disposal Act (SDWA) in 1965. SDWA set minimum safety requirements for local landfills and formed the framework for states to better control waste disposal.

Highlight 2-1: Trends in MSW Landfill Ownership

EPA promulgated federal regulations in 1991 governing the technical criteria for MSW landfills under Subtitle D of RCRA. While compliance with these regulations provided greater protection to human health and the environment, they also made it more complex to operate MSW landfills.

The result was a trend towards larger, regional and privately-owned MSW landfills. In 2004, an estimated 64% of landfills were publicly owned. These landfills accounted for only 17% of permitted MSW landfill capacity, while privately owned MSW landfills accounted for 83% of capacity nationwide.

After EPA was formed in 1970, the federal government began working with states and industry to better understand the issues encountered and dangers posed by increasing volumes of waste. In 1976, Congress passed RCRA, which amended SDWA, to ensure that wastes are managed in manner that protects human health and the environment. Subtitle D of RCRA covers non-hazardous waste landfills and banned open dumping and provided basic requirements for safe disposal of MSW (EPA 2002). MSW landfills are often called “Subtitle D landfills,” which is a reference to RCRA.

In 1991, EPA established new standards for MSW landfills. These standards are codified in the regulations at 40 CFR Part 258 and provide for location restrictions, operating criteria, design criteria, ground water monitoring and corrective action, closure and post-closure care criteria and financial assurance criteria. The regulations apply to MSW landfills that received waste after October 9, 1993. Landfills that received waste after October 9, 1991, and stopped receiving waste before October 9, 1993, are subject to closure provisions in 40 CFR §258.60(a). The criteria do not apply to MSW landfills that stopped receiving waste prior to October 9, 1991.

EPA’s regulations under 40 §258.2 define a MSW landfill unit in part as a discrete area of land or excavation that receives household waste. In addition, EPA’s regulations provide that MSW landfill units may also receive other types of RCRA non-hazardous wastes, such as commercial solid waste, non-hazardous sludge, conditionally exempt small quantity generator (CESQG) waste and industrial solid waste.

States play a key role in the implementation of non-hazardous waste regulations under RCRA Subtitle D. The law authorizes states to implement programs to ensure MSW landfills comply with federal requirements, and states may adopt more stringent requirements. RCRA establishes requirements for state permit programs and requires that EPA determine the adequacy of these state programs (40 CFR §239). Currently, all 50 states operate approved RCRA Subtitle D programs.

2.2 MSW LANDFILL DESIGN STANDARDS, OPERATING REQUIREMENTS AND MAJOR SYSTEM COMPONENTS

Federal and state MSW landfill regulations include design standards and operating requirements. Depending on the date when the landfill started accepting waste, MSW landfill regulations could include requirements for (40 CFR §258):

- **Location** – Location restrictions based on proximity to airports, floodplains, wetlands, unstable areas, fault areas and seismic impact zones.
- **Design** –
 - A composite liner comprising a flexible membrane (geomembrane) overlaying 2 feet of compacted soil lining the bottom and sides of the landfill, designed to protect ground water and underlying soil from leachate releases.
 - A leachate collection and removal system, generally located on top of the composite liner to remove leachate from the landfill for treatment and disposal.
- **Operating practices** –
 - Covering waste frequently with soil or other materials to control odor, blowing litter, fires, disease vectors (e.g., insects and rodents) and scavenging.
 - Implementation by owners/operators of a program for detecting and preventing the disposal of regulated hazardous waste.
- **Ground water monitoring and corrective action** – Installation and testing of ground water wells to detect and assess ground water contamination and establishment of necessary corrective measures for identified releases.
- **Closure and post-closure care** – Installation of a final landfill cover system and providing long-term care of closed landfills.

MSW landfills that received waste after October 9, 1991, were required to meet the Subtitle D closure criteria at 40 CFR §258.60(a), including the requirement that the final cover system be designed to minimize water infiltration and surface erosion. Covers at these landfills typically include a “cap” or “cover system” consisting of a low permeability soil or clay layer beneath a vegetated surface layer. Landfill cover conditions at landfills that stopped receiving waste by October 9, 1991 (i.e., landfills exempted from the Subtitle D regulations) will be more variable and unknown. This document focuses on MSW landfills that were closed according to the Subtitle D closure criteria. Project stakeholders should consult engineers with expertise in landfill engineering when considering the applicability of this information to landfills exempted from Subtitle D.

Under the Clean Air Act, a landfill gas collection system is required on landfills with a design capacity greater than 2.5 million megagrams (Mg) and emissions of non-methane organic compounds greater than 50 Mg/year, as defined by new source performance standards (NSPS) and emission guidelines (EG). Under the NSPS and EG, the landfill surface must be monitored for methane concentrations. If exceedances are detected, corrective action must be taken. These actions could include performing cover maintenance or adjusting collection system operations (e.g., adjusting vacuum at gas extraction wells near the exceedance).¹¹

Figure 2-1 shows common MSW landfill components referred to in subsequent sections of this document. These include a composite liner with an overlaying drainage layer and leachate collection system, landfill gas extraction wells and collection system, composite cap, and groundwater and landfill gas monitoring systems.

¹¹ For landfill gas collection system requirements, see 40 CFR §60.752. For compliance requirements, including surface methane gas monitoring and corrective action requirements, see 40 CFR §60.755.

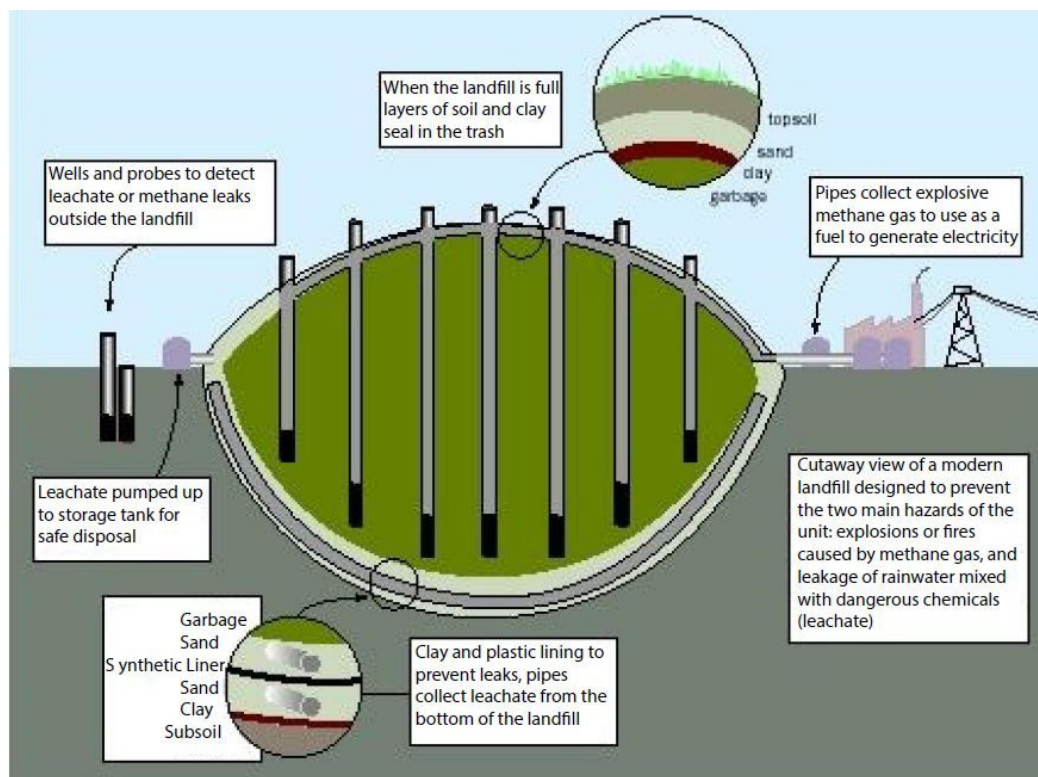

Source: EPA (2014)

Figure 2-1: Cross-section of a MSW landfill

2.3 CLOSURE AND POST-CLOSURE CARE

Once a landfill has stopped accepting waste, it must be closed, maintained and monitored according to federal MSW landfill closure and post-closure regulations at 40 CFR Part 258, Subpart F, and applicable state regulations.¹² Closure standards for MSW landfills require that owners/operators install a final cover and develop a post-closure plan. Final covers must be designed to minimize infiltration through the cover and into the waste and must include features designed to minimize erosion. Specific criteria are outlined in 40 CFR §258.60. States may approve alternative cover designs that provide equivalent protection. States may also establish alternative requirements for small MSW landfills (i.e., that received less than 20 tons MSW/day), if the requirements are protective of human health and the environment. The post-closure plan must include a description of monitoring and maintenance activities and a description of the planned uses of the landfill property after closure.

MSW landfill regulations require that owners/operators monitor and maintain the landfill for 30 years after the landfill is closed. This is referred to as the “post-closure care” period. The regulations allow states to approve a shorter post-closure care period if the owner/operator can demonstrate that a shorter period is sufficient to protect human health and the environment. States can lengthen the post-closure period if the state determines that this is necessary to protect human health and the environment. Activities required during post-closure care include:

- Maintaining the integrity and effectiveness of any final cover, including monitoring settlement and inspecting the cover for failures and erosion.
- Maintaining and operating the leachate collection system.
- Monitoring ground water for contamination.
- Maintaining and operating the gas monitoring system.

¹² Currently, all 50 states have approved RCRA Subtitle D programs and are responsible for administering MSW landfill closure and post-closure care regulations.

The regulations specify that any use of the land during the post-closure period must not disturb the integrity of the landfill cap and other waste containment systems or the functioning of the monitoring systems, except in specified circumstances as provided in 40 CFR Part 258 Subpart F. States may issue post-closure permits that specify permitted uses, monitoring and maintenance requirements to ensure that permitted uses do not compromise the integrity and protectiveness of landfill systems and restricted activities (e.g., operation of heavy equipment on the cover). At the end of the post-closure care period, the owner/operator must certify that the post-closure care has been completed in accordance with the post-closure care plan and must place the certification in the operating record.

If a PV system is anticipated at the time of landfill closure, the design and installation of the system can be integrated into the post-closure plan. If a solar project is being considered at a landfill that is already closed and has a permitted post-closure use (other than solar PV), requirements for obtaining approval of a new permitted use must be considered. Most states will consider new permitted uses if they do not disturb the integrity of the cover and other waste containment systems and functioning of monitoring systems. Some states may discourage proposed PV solar designs that involve penetration of the landfill cover.

Prior to considering a PV system on a closed landfill, developers should consult with and work closely with state and local regulators to understand post-closure care and use requirements and associated planning and permitting processes.

3. SOLAR PV OVERVIEW

3.1 HOW PV WORKS

Solar PV technology converts energy from solar radiation directly into electricity. Solar PV cells are the electricity-generating component of a solar energy system. When sunlight (photons) strikes a PV cell, an electric current is produced by stimulating electrons (negative charges) in a layer in the cell designed to give up electrons easily. The existing electric field in the solar cell pulls these electrons to another layer. By connecting the cell to an external load, this current (movement of charges) can then be used to power the load, e.g., light bulb.

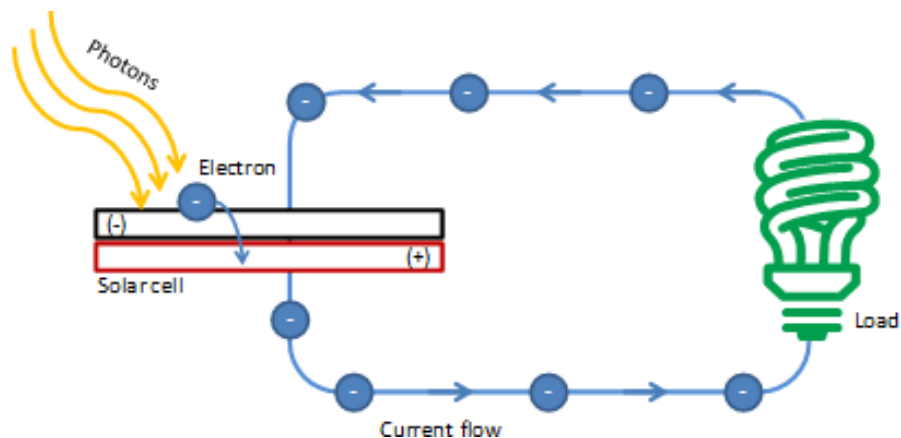

Source: EPA

Figure 3-1: Generation of electricity from a PV cell

PV cells are assembled into a PV panel or module. PV modules are then connected to create an array. The modules are connected in series and then in parallel as needed to reach the specific voltage and current requirements for the array. The direct current (DC) electricity generated by the array is then converted by an inverter to useable alternating current (AC) that can be consumed by adjoining buildings and facilities or exported to the electricity grid. PV system size varies from small residential (4-7 kW), commercial (100 kW-2 MW), to large utility scale (5+ MW) (Feldman et al. 2021). Central distribution plants are also currently being built on the 100 MW+ scale. Electricity from utility-scale systems, such as solar on landfills, is commonly sold back to the electricity grid.

3.2 MAJOR SYSTEM COMPONENTS

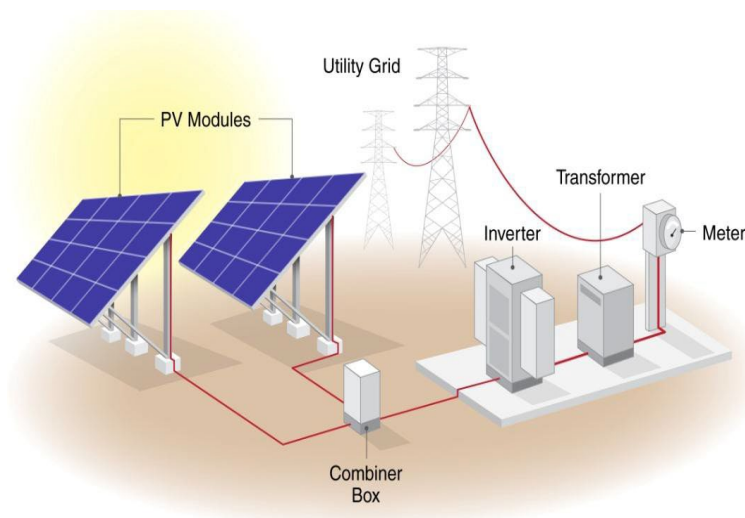

Source: NREL

Figure 3-2: Ground mount array diagram

A typical PV system is made up of several key components including:

- PV modules.
- Inverter.
- Balance-of-system components.
- Battery storage (optional).

These, along with other PV system components, are discussed in turn below.

3.2.1 PV Module

Module technologies are differentiated by the type of PV material used, resulting in a range of conversion efficiencies from light energy to electrical energy. The module efficiency is a measure of the percentage of solar energy converted into electricity.

Two common PV technologies that have been widely used for commercial- and utility-scale projects are crystalline silicon and thin film. Additional PV technologies are also commercially available but are not covered in this document.

3.2.1.1 Crystalline Silicon

Traditional solar cells are made from silicon. Silicon is quite abundant and nontoxic. It builds on a strong industry from both the supply (silicon industry) and product side. This technology has been demonstrated as a consistent and high efficiency technology over 30 years in the field. Crystalline silicon modules account for more than 90 percent of the global PV market (Heath et al. 2020). The performance degradation (reduction in power generation due to long-term exposure) is under 1 percent per year (Jordan and Kurtz 2013). Silicon modules have typical power-production warranties in the 25- to 30-year range but can continue producing energy beyond this timeframe.

Silicon-based solar cells are generally divided into mono- and multi-crystalline technologies. The main difference between the technologies is that mono-crystalline solar cells are made from single silicon crystal while multi-crystalline solar cells contain multiple silicon crystals. The single-crystal structure of mono-crystalline cells allows electrons to move freely and generate electricity; therefore, they are more efficient than multi-crystalline panels. Laboratory tests show the conversion efficiency of mono-crystalline panels at 25 percent and multi-crystalline panels at 20 percent.¹³ The advantage with multi-crystalline panels is that they are cheaper to manufacture. Typical overall efficiency of commercially available silicon solar modules is between 18-22 percent under standard test conditions. This range of efficiencies represents significant variation among the crystalline silicon technologies available.

Figure 3-3 shows two examples of crystalline solar modules: mono- and multi-silicon installed on tracking mounting systems.



Source: SunPower Corporation

Source: NREL PIX 13823

Figure 3-3: Mono- and multi-crystalline solar modules

¹³ For information on U.S. Department of Energy, Office of Energy Efficiency and Renewable Energy (EERE) research on crystalline silicon PV panels, see energy.gov/eere/solar/crystalline-silicon-photovoltaics-research.

3.2.1.2 Thin Film

Thin-film PV cells are made from amorphous silicon (a-Si), non-silicon materials such as cadmium telluride (CdTe) or copper indium gallium (di)selenide (CIGS). These cells use layers of semiconductor materials only a few micrometers thick. Due to their unique nature, some thin-film cells are constructed into flexible modules, enabling unique mounting options such as solar energy covers for landfills. Other thin film modules are assembled into rigid constructions that can be used in fixed tilt or, in some cases, tracking system configurations.

Current overall efficiency of a thin-film module is between 10-12 percent for a-Si, 12-14 percent for CIGS and 18 percent for CdTe.¹⁴ Figure 3-4 shows thin-film solar modules.



Source: Republic Services Inc.

Source: NREL PIX 14726

Source: NREL PIX 17395

Figure 3-4: Thin-film solar modules installed on (i) solar energy cover and (ii/iii) fixed tilt mounting systems

Industry-standard warranties of both crystalline and thin film PV modules typically guarantee system performance of 80 percent of the rated power output for 25 years. After 25 years, they will continue producing electricity at a lower performance level.

3.2.2 Inverter

The purpose of inverters is to convert DC electricity from the PV array into AC to be able to connect seamlessly to the electricity grid. Inverter conversion efficiencies can be as high as 98.5 percent. There are two primary types of inverters for grid-connected systems: string and micro inverters. Each type has strengths and weaknesses and may be recommended for different types of installations.

String inverters are the most common type of inverters. They handle power output from a row of PV panels. These inverters tend to be cheaper on a capacity basis and tend to have higher efficiencies and lower operation and maintenance (O&M) costs. Warranties typically run between 5 and 12 years, with 12 years being the current industry standard. On larger units, extended warranties up to 20 years are possible. Given that the expected life of the PV modules is 25-30 years, an operator can expect to replace a string inverter at least one time during the life of the PV system. While string inverters are the most reliable and cheap, there can be several disadvantages: 1) since string inverters connect several panels together, shading or debris on one panel can impact the power output of the total system; 2) unless the string inverter is oversized, expansion of the solar plant is not feasible, without adding more inverters or replacing the existing inverter; and 3) in case of inverter failure, the whole system is down. To overcome these disadvantages, power optimizers are used. They are a module level power electronics that increases the power yield of each module before it sends an optimized DC voltage to the string inverter.

Microinverters are dedicated to the conversion of a single PV module's power output. The AC output from each module is connected in parallel to create the array. This technology is relatively new to the market and is in limited use in larger systems due to potential increase in O&M associated with significantly increasing the number of inverters in a given array. Current microinverters range in size between 175 watts (W) and 440 W. These inverters can be the most expensive option per watt of capacity. Warranties range from 10 to 20 years. Small projects with irregular modules and shading issues typically benefit from microinverters. Figure 3.5 shows a schematic of the configuration of solar panel with different inverters.

¹⁴ For information on efficiencies of a-Si thin film and other solar cells and modules, see Green et al. (2020). For information on EERE research on PV technologies, including CIGS and CdTe thin film technologies, see energy.gov/eere/solar/photovoltaics.

With technological advancements, inverters are getting “smarter” and they now also enable grid support functions such as: 1) capability of “riding through” minor disturbances to frequency or voltage instead of shutting down the Distributed Energy Resources (DERs); 2) capability to inject or absorb electricity into or from the grid to regulate voltage and frequency levels; and 3) capability to provide a “soft start” after power outages (McLaren 2014). Due to these advancements, some states require early-stage smart inverters for all the new solar projects.¹⁵

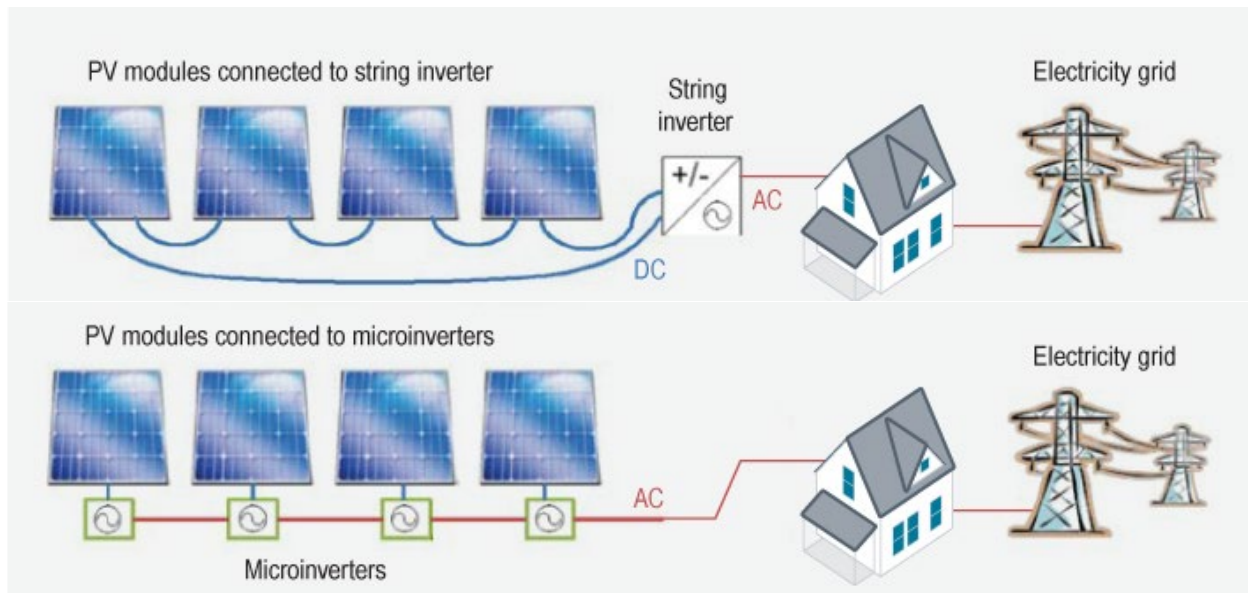

Source: DOE (2015)

Figure 3-5: Schematic of PV system with various inverter system.

3.2.3 Balance-of-System Components

In addition to the solar modules and inverter, a solar PV system consists of other parts called balance-of-system components, which include:

- Mounting racks and hardware for the modules.
- Wiring for electrical connections.

3.2.3.1 Mounting Systems

The structure holding the PV modules is referred to as the mounting system. The mounting system can be either directly anchored into the ground (via driven piers or concrete footers) or ballasted on the surface without ground penetration. Mounting systems should be selected and designed to withstand maximum local wind loads, which range from 90–120 mph in most areas and 130 mph or more for areas with hurricane potential. Depending on the region, snow and ice loads are also considered in the mounting system design. For landfill applications, mounting system designs will be primarily driven by these considerations coupled with settlement concerns. More details on settlement and anchoring systems can be found in Chapters 4 and 5.

Typical ground-mounted systems can be categorized as fixed-tilt or tracking. Fixed-tilt mounting systems are characterized by modules installed at a set angle, typically based on site latitude and wind conditions, to maximize exposure to solar radiation throughout the year. Fixed-tilt systems are used at many landfill sites. Fixed-tilt systems typically have lower maintenance costs but generate less energy (kilowatt-hours (kWh)) per unit power (kW) of capacity than tracking systems (Figure 3-6).

Tracking systems rotate the PV modules to follow the sun as it moves across the sky. This increases energy output but typically involves greater maintenance and equipment costs. Single-axis tracking, in which PV modules are rotated on a single axis, can increase energy output by up to 15-25 percent or more (Figure 3-7). With dual-axis

¹⁵ See, for example, information and recommendations from the California Public Utility Commission’s Smart Inverter Working Group (cpuc.ca.gov/rule21/).

tracking (Figure 3-8), PV modules are rotated to directly face the sun all day, potentially increasing output by up to 35 percent or more. Due to alignment requirements of the mounting system, single- and dual-axis trackers are not generally deployed on landfill cells, as discussed below. Tracking systems may be more appropriate for landfill buffer zones, when permitted, where settlement concerns are typically less significant.

The selection of mounting type is dependent on many factors including installation size, electricity rates, government incentives, land constraints, latitude and local weather. Landfill applications raise additional design considerations due to differential settlement, which can impact both structural integrity and energy generation of the PV system.

It is important to account for landfill settlement in the mounting system design. Impacts of settlement on energy performance may be more severe for tracking systems, and, depending on the degree of predicted settlement, fixed tilt systems may be preferable for installation on the top of the landfill—an area referred to as the “top deck.” Tracking systems could be sited in buffer areas around the landfill when permitted. The best way to ensure a successful application is to assume there will be some settlement and to use mounting system designs that can be adjusted to accommodate this. In addition, all PV systems need to consider the landfill monitoring operations and ongoing site conditions.

Selection of the mounting system is also heavily dependent on anchoring or foundation selection. The mounting system design will also need to meet applicable local building code requirements with respect to snow, wind and earthquake factors. Further, selection of mounting types should consider frost protection needs especially in cold regions. This topic is covered in additional detail in Chapters 4 and 5, including site-specific considerations for landfill applications.



Source: NREL PIX 17394

Figure 3-6: 2-Megawatt peak (MWp) PV system with fixed tilt on former landfill in Fort Carson, Colorado.



Source: NREL PIX 15280

Figure 3-7: PV system with single-axis trackers installed on former landfill at Nellis Air Force Base, Nevada.



Source: NREL PIX 04827

Figure 3-8: PV system with dual-axis trackers.

3.2.3.2 Wiring for Electrical Connections

Electrical connections, including wiring, disconnect switches, fuses and breakers are required to meet electrical code (e.g., National Electrical Code (NEC) Article 690, Solar PV Systems) for both safety and equipment protection.

In most traditional applications, wiring from arrays to inverters and inverters to point of interconnection is generally run as direct burial through trenches. In landfill applications, this wiring may be required to run through

above-ground conduits due to restrictions on cap penetrations or other concerns. Use of explosion-proof conduit fittings and other electrical equipment may be required for conduits that penetrate the cap (where allowed) and in other situations where landfill gas creates an explosion hazard.

Developers should review post-closure use requirements with landfill owners or operators and state and local officials to identify restrictions on cap penetrations, acceptable conduit locations and requirements for explosion-proof electrical fittings and equipment. Developers should reflect these restrictions and requirements in the cost quote for the overall system.

3.2.4 Batteries

Batteries are devices that store and discharge electricity on demand through an electro-chemical process. A typical battery contains two electric terminals called cathode and anode that are separated by electrolyte connected to an electric circuit. Electric current travels between the cathode and anode through the electrolyte; the direction of current depends on whether the cell is charging or discharging. Batteries come in many different chemistries, each with different characteristics, e.g., lead-acid batteries, lithium-ion and flow batteries.

The most common commercial- and utility-scale battery types are lithium-ion batteries, which represent more than 80 percent of the installed market capacity due to their declining costs and high energy density. Cost and performance for battery storage in the form of a 4-hour to 0.5-hour, utility-scale, lithium-ion battery system with a 15-year assumed life is \$380 to \$495 per kWh (Fu et al. 2018). The round-trip efficiency is 86 percent (i.e., DC-to-storage-to-DC energy efficiency of the storage bank, or the fraction of energy put into the storage that can be retrieved) (Mongird et al. 2020).

Batteries provide the ability to store solar energy for later use and provide several grid-services including peak shaving, frequency regulation, voltage support, phase balancing, energy trading and PV smoothing. Peak shaving is when the battery discharges during “on-peak” period to reduce peak energy consumption from the grid. Since landfills do not have large need for on-site consumption peak shaving benefits are not applicable. However, batteries can discharge to the grid during peak hours at a premium to improve profitability, this application is also called energy arbitrage. Frequency regulation is a constant adjustment of power to maintain frequency at nominal levels to ensure grid stability. Since batteries can respond quickly, they are useful for frequency regulation applications. Voltage support is when power is needed to maintain voltage within limits. Phase balancing is the process of keeping the load at each phase as balanced or equal as possible. Energy trading is where bulk energy is bought or sold and moved to an area of need. Depending on the available policy, incentives and rate structure in the region, batteries integrated with solar can add additional economic value. It is important to consider all the available incentives, rate structures and system performance to identify optimal battery size and dispatching schedule. Tools such as the REopt can aid in this analysis.¹⁶

3.2.4.1 Battery Configuration

When PV and battery storage is coupled with PV system, they can either be connected in an AC-coupled or a DC-coupled configuration. An AC-coupled system needs both a PV inverter and a bidirectional inverter, and there are multiple conversion steps between DC and AC to charge or discharge the battery. Figure 3-9 shows an AC-coupled system with a common coupling point on the grid. AC-coupled systems have several advantages since the PV systems and batteries are independent of each other. First, the battery packs of AC-coupled systems can be larger leading to reduced soft costs. Second, the PV system or the battery system can be upgraded separately therefore retrofitting is easier. Finally, the location of the battery system is not dependent on the location of PV system thus providing flexibility for project planning and maintenance.

A DC-coupled system can be of two types: flexible charging and PV-only charging. Flexible charging is where the PV and battery system are coupled on the DC side of one shared bidirectional inverter allowing both the PV system and the grid to charge the battery. In PV-only charging, the battery is allowed to be charged only by the PV system controlled by a DC to AC-only inverter. While greater coupling is important, PV-only charging configuration is

¹⁶ The Renewable Energy Integration & Optimization (REopt) techno-economic decision support platform can be accessed at reopt.nrel.gov/.

important because federal incentives (investment tax credit (ITC)) only apply to this configuration. DC-coupled systems offer several advantages when compared to AC-coupled systems. First, since only one inverter is needed DC-coupled systems experience reduced costs. Second, due to a lower number of AC to DC or DC to AC conversion steps the round-trip efficiency of the system is higher. Finally, excess PV generation that is clipped in AC-coupled systems due to inverter constraints can be sent directly to the battery, improving system economics. Given the discussion, system configuration should be considered for determining the benefits and cost of the project.

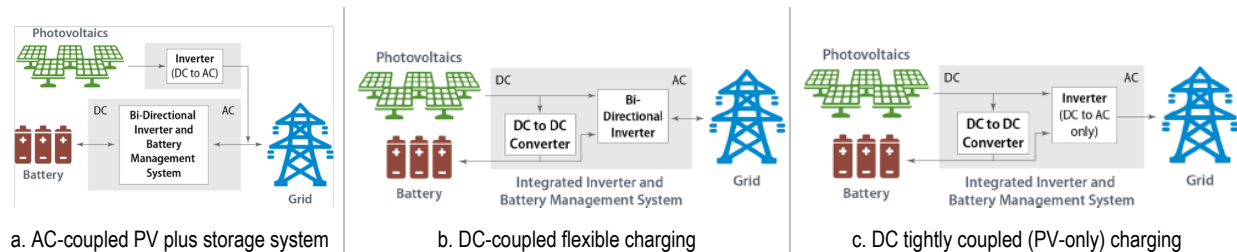

Source: Denholm et al. (2017)

Figure 3-9: PV plus storage system configurations.

Highlight 3-1: Microgrid and Battery Storage Explored

As an electricity generating project, Green Mountain Project (GMP) decided to design its solar system as a microgrid. A microgrid is a set of interconnected loads and distributed energy resources that can be used as a single controllable electricity entity. The primary reason for developing a microgrid is to provide reliable power to critical loads during loss of grid power. When the system is “islanded,” or operating independent from the grid, the microgrid operator and control system manage available generation and the loads on the system to satisfy energy requirements. A grid-connected microgrid like the one at Stafford Hill Solar Farm can provide benefits including generation capability and load management, as well as ancillary services such as operating reserves, frequency regulation and reactive power support for loads such as that resulting from air conditioners. Microgrids provide these functionalities by aggregating distributed energy resources such as solar, and through improved command and control capabilities, better communication systems and energy storage.

GMP wanted to include a battery system in its landfill solar installation to effectively create a microgrid system for several reasons. In GMP’s view, the system reflected how they projected the electricity grid to perform in the future using energy storage and distributed generation, and to accrue other potential grid benefits, such as resiliency provided by the system’s islanding capabilities. The company wanted to use the battery system to test the ability to smooth out fluctuations related to solar intermittency and reduce costs for customers by reducing peak demands. The city of Rutland also realizes benefits since the storage system can power the city emergency shelter at the high school in the event of wide-scale power outages and weather events.

The energy storage system is perhaps the most unique feature at Stafford Hill Solar Farm. With 4 MW of battery storage in its inverter stations, the site is the first installation that includes a microgrid powered only by solar and batteries with no other fuel source. The regulation system maintains voltage when the system is connected to the grid and facilitates “islanding” in an emergency. In the event of an outage, the Stafford Hill circuit can be disconnected from the grid to provide electricity to the city’s emergency shelter at the high school. GMP’s on-call crews can get to the system and have it generating within about an hour. The emergency system was originally designed to connect through the grid distribution system, but GMP is building a separate distribution line. Having the system directly tied to the school will provide more flexibility if the distribution system goes down and will allow GMP to test the emergency system without having to cut grid power.

The Stafford Hill battery system includes lithium ion and lead acid batteries. According to GMP, the battery storage represents roughly half of the total \$10 million system cost. The life of the batteries is a function of duty cycle (how often the system draws on the batteries), but GMP is expecting a minimum of 10 years before cell replacements are required. In addition to providing the city access to emergency power and helping GMP meet electricity demand when solar power is unavailable, the energy storage system benefits the grid. Such benefits include enhanced grid reliability, power load management, instantaneous voltage regulation and opportunities for energy arbitrage (i.e., using stored power instead of more expensive peak power). The batteries also give GMP flexibility in responding to and optimizing energy demand.

STAFFORD HILL SOLAR AT-A-GLANCE

- Located in Rutland, VT.
- Former 15-acre MSW landfill, which closed in the 1980s.
- 2.3 MW solar PV installation on 9 acres.
- 7,772 multi-crystalline silicon panels.
- Developed in 2015 by Vermont utility GMP through a partnership among federal, state, utility, industry and nongovernmental organizations (NGOs).
- Includes 4 MW of additional energy storage in the form of lead acid and lithium-ion batteries.
- System acts as a microgrid, providing power to the city's emergency center at the high school.
- Provides economic benefits, including near-term annual benefits from the storage component of \$350,000 - \$700,000 and annual land lease revenue of \$30,600 to the city.



3.2.5 PV System Monitoring

Monitoring PV systems can be essential for reliable functioning and maximum yield of a system. It can be as simple as reading values such as produced AC power, daily kWh, and cumulative kWh locally on an LCD display on the inverter. For more sophisticated monitoring and control purposes, environmental data such as module temperature, ambient temperature, solar radiation and wind speed can be collected. Remote control and monitoring can be performed by various remote connections. Systems can send alerts, status messages and notifications for maintenance requirements to the control center or user. Data can be stored in the inverter's memory or in external data loggers for further system analysis. Collection of this basic information is standard for solar systems and not unique to landfill applications.

Weather stations are typically installed at large-scale systems. Weather data such as solar radiation and temperature can be used to predict energy production, enabling comparison of the target and actual system output and performance and identification of under-performing arrays. Operators can use these data to identify required maintenance, shade on modules, accumulated soiling on modules, etc. Monitoring system data can also be used for outreach and education. This can be achieved with publicly available, online displays, wall-mounted systems or even smart phone applications.

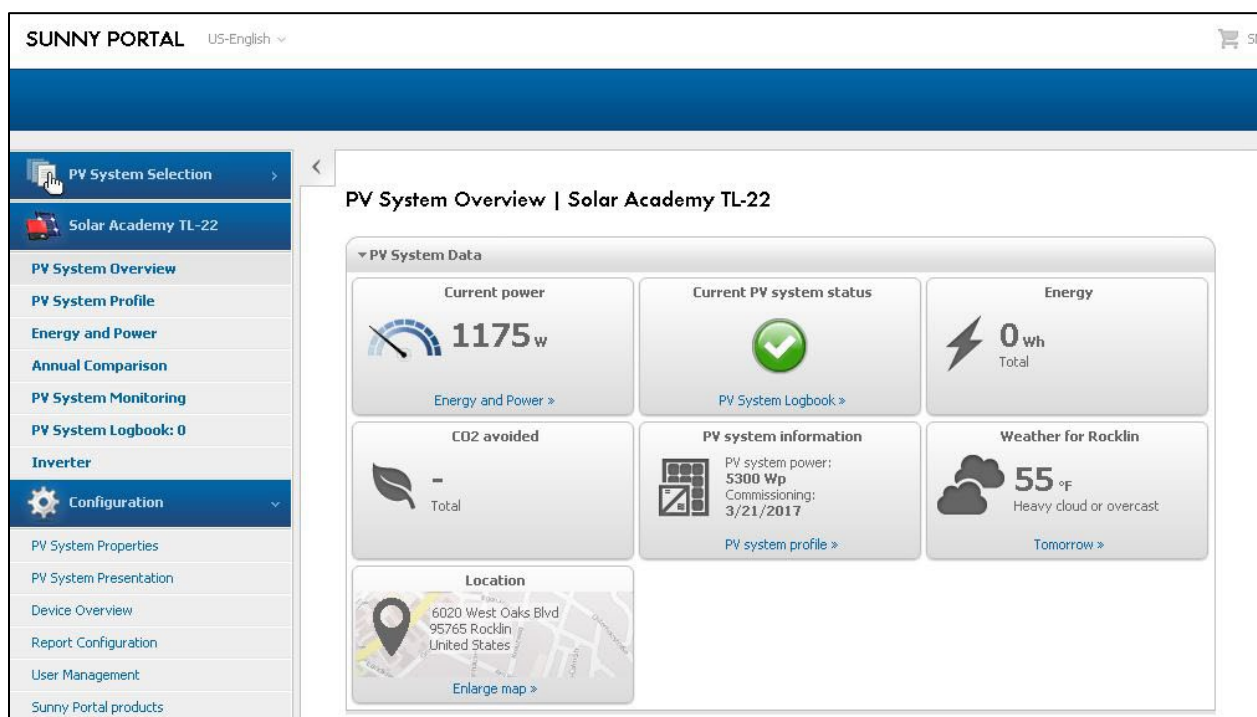

Source: SMA Solar Technology (2017)

Figure 3-10: A representative figure of a PV system monitoring dashboard.

3.3 COST OVERVIEW

3.3.1 Cost Trends and General Rule of Thumb for PV Costing

The cost of a PV system depends on the system size and other factors such as geographic location, labor rates, mounting system and type of PV module, among others. Significant reductions in PV system installed costs were observed from 2010 to 2020. The national average cost for utility-scale fixed tilt ground mounted systems has declined from \$4.70 per watt DC in 2010 to \$0.94 per watt DC in 2020. With a growing market and increasing supply, further cost reductions are expected as market conditions evolve. However, landfill solar may be more expensive to build than normal ground-mounted solar systems due to additional design consideration (Solar Power World 2019). Figure 3-11 shows the national average cost per watt DC of PV systems from 2010 to 2020 for residential, commercial, utility-scale fixed and single-axis tracking projects.

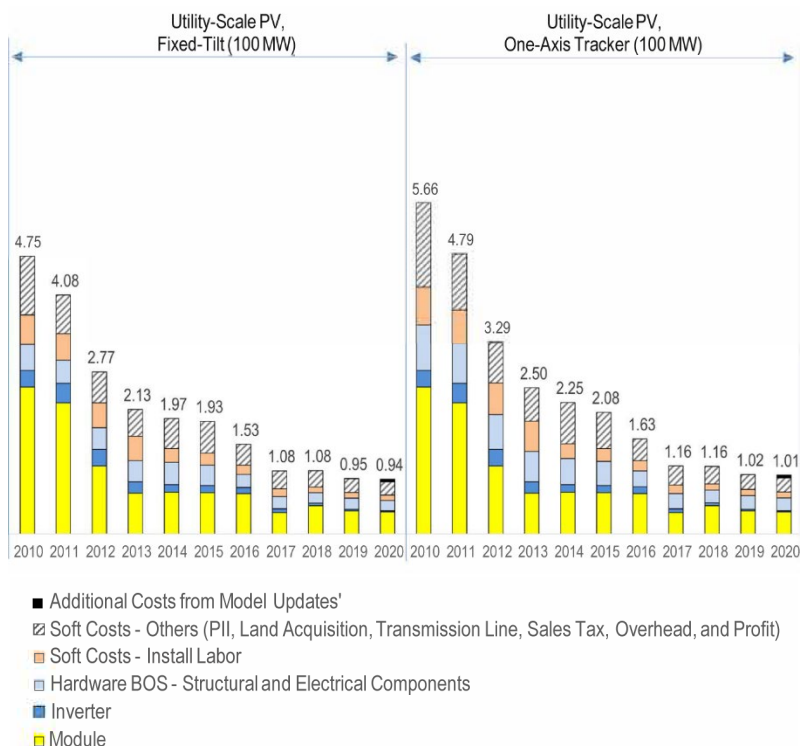

Source: Feldman et al. (2021)

Figure 3-11: PV system cost benchmark summary (inflation-adjusted) from 2010 to 2020.

3.3.2 Cost per Watt Breakdown

Historically, PV modules have represented approximately half or more of PV system costs. Based on significant price reductions due to a variety of market forces, module costs have represented anywhere between 31-43 percent of overall system costs as of 2020. Costs for each component category and other soft costs are shown in figure 3-12 as a proportion of overall system cost.

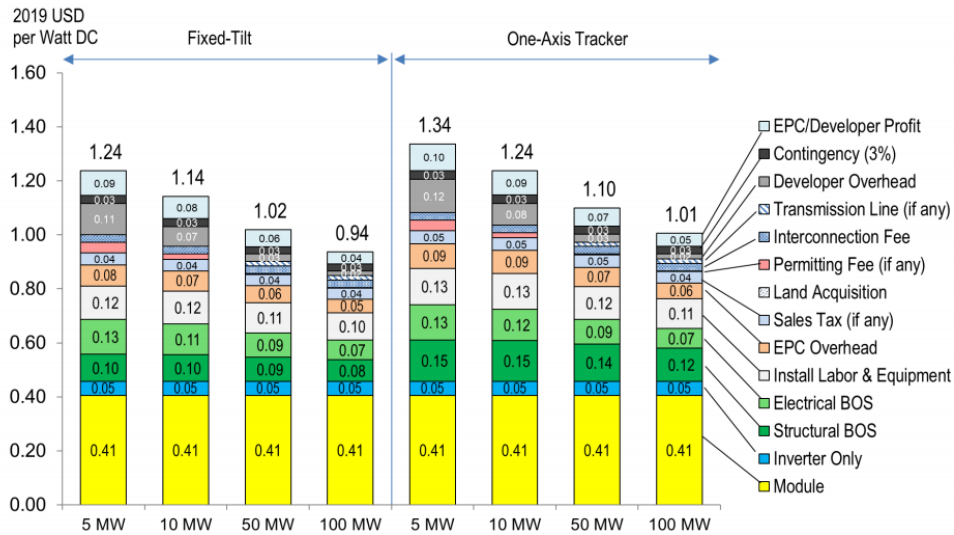

Source: Feldman et al. (2021)

Figure 3-12: Utility-scale PV system cost breakdown.

3.3.3 Operation and Maintenance Cost

O&M cost is an important factor for PV costing. Figure 3-13 breaks down the O&M cost into nine categories: inverter replacement; operations administration; module replacement; component parts replacement; system inspection and monitoring; module cleaning and/or vegetation and pest management; land lease; property tax; and insurance, asset management and security. Annual O&M cost for utility-scale system vary between \$16-\$18 per kW_{DC} (Feldman et al. 2021, Walker et al. 2020).

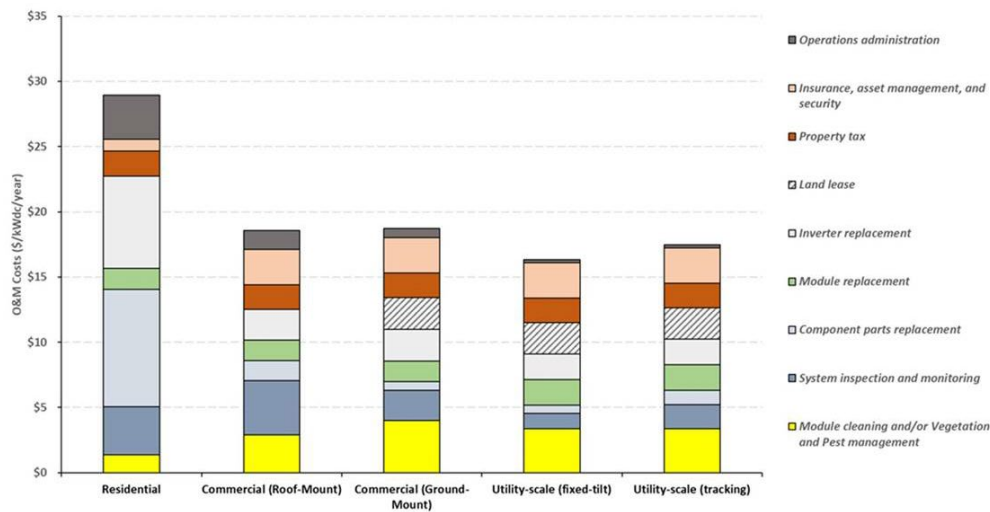

Source: Feldman et al. (2021)

Figure 3-13: Q1 2020 residential, commercial and utility-scale O&M costs by category.

3.4 TYPICAL SOLAR PV SITING PROCESS

The basic phases for solar PV siting across the different types of renewable energy projects are similar. The process can be tailored and adapted to address unique or special needs inherent in site cleanup and reuse on various site types. In some instances, multiple phases can be combined or accelerated without compromising cleanup quality or development success, making it potentially possible to design and site a renewable energy facility at any step in the land cleanup process.

- **Pre-screening Analysis/Site Selection** - Screen sites to identify and prioritize locations for further study. Preliminary screenings are often based on maps of renewable energy resources, prevailing utility rates and incentives to determine if the project merits a more serious investment of the time and resources required by a feasibility analysis.
- **Renewable Energy Feasibility Analysis** (Site-specific assessment) - A detailed analysis of the project provides technology and financing recommendations; identifies all physical issues, including space for the systems; determines technical performance potential and economic viability; and identifies environmental, social or other constraints that may impede project execution.
- **Design and Development** - Design and planning of the physical aspects of the project, including documenting the intent of the design and creating the protocol by which the system performance will be evaluated. This step also covers any required instrumentation and the arrangement and negotiation of financial, regulatory, contractual and other nonphysical aspects.
- **Construction and Commissioning** - Construction or installation of the renewable energy facility and assessment of the degree to which the system fulfills the intent of the design.
- **Performance Period** - O&M activities performed throughout the operating period of the facility, including regular confirmation that the facility is working according to specification and warranties through measurement and verification.
- **Decommissioning** - Removing a facility at the end of a project's life. This process involves issues such as equipment replacement, post-closure permit revision and new financing; and negotiating a new lease agreement, purchase power agreement (PPA) and buyer for the resultant renewable energy certificates (RECs), etc.

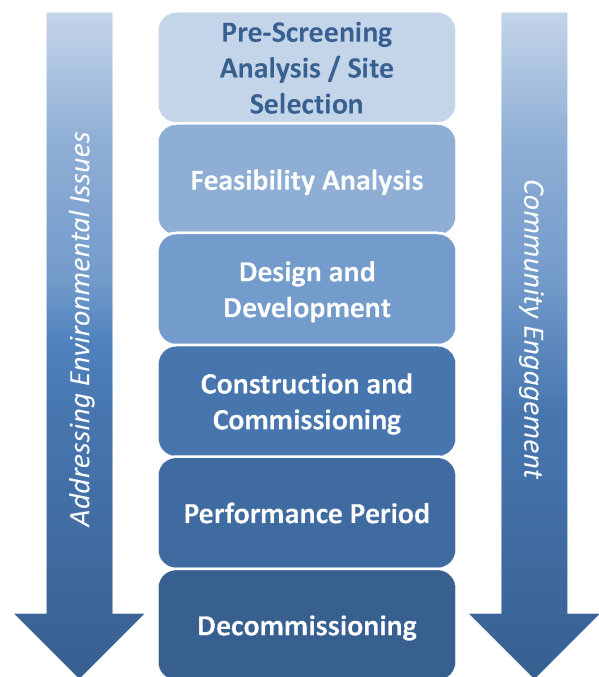

Source: EPA

Figure 3-14: Renewable energy project development process

4. FEASIBILITY CONSIDERATIONS UNIQUE TO LANDFILLS

Many MSW landfills are well-suited for solar development, but not every landfill is an ideal candidate. Since some landfills are better suited than others for solar PV development, candidate landfills should be carefully selected. Determining the feasibility of siting solar PV on a landfill is typically conducted through a phased process involving a preliminary, decision-grade feasibility study and, if the preliminary study suggests the landfill may be a good candidate, a more detailed, investment-grade feasibility study. Decision- and investment-grade feasibility studies examine similar factors, though investment-grade feasibility studies involve a greater level of information collection and more rigorous analyses.

A decision-grade feasibility study usually involves gathering readily available information regarding the general setting for the project, landfill characteristics, appropriate PV technologies and regulatory requirements to determine if a project merits a more serious investment of time and resources. As an initial screening, solar resource, usable acreage, landfill settlement potential and consistency with regulatory requirements, including the landfill closure plan, should be considered. If, for example, the usable land associated with a landfill is limited or the landfill was closed recently and is still undergoing significant settlement, it may not be a good candidate and may not warrant further review. EPA's RE-Powering Mapper (described in greater detail in Appendix B) and the landfill-specific section of the RE-Powering Electronic Decision Tree (discussed in Appendix B) are examples of tools that can help screen sites and conduct a decision-grade feasibility study.

A decision-grade feasibility study typically involves development of a "conceptual design" of the PV system, which is a more generalized characterization of the PV system components in terms of module type, mounting system, anchoring system and inverters, plus cost estimates for these components and their installation. This conceptual design is then used to develop estimates of the PV system's costs, benefits and performance characteristics, and to determine if a project warrants further consideration based on economic metrics, operational requirements and regulatory considerations. Decision-grade feasibility studies can be performed by landfill operators, PV developers or independent consultants to arrive at a "go or no-go" decision on a landfill-based PV project.

Following the decision-grade feasibility study, promising projects may undergo a more in-depth, investment-grade feasibility study. Project sponsors generally conduct these studies to verify the information and assumptions contained in the decision-grade feasibility assessment; collect and analyze additional information as necessary; and develop a preliminary engineering design of the system optimized for the desired performance characteristics of the system and site conditions. An investment-grade feasibility study builds on the decision-grade analysis and typically provides information that can be used for obtaining financing for the project, if desired. These studies typically include detailed performance modeling of the PV system's projected energy output characteristics and a financial *pro forma* detailing the costs, revenues/savings and economic metrics (e.g., internal rate of return, levelized cost of energy and payback period) over the system life. Investment-grade feasibility studies are typically conducted by professionals such as project developers or independent consultants with experience in landfill engineering, PV system design and development, PV system performance modeling and financial analysis of PV projects.

It is important when assessing the feasibility of siting a solar project on a landfill to think of the landfill in terms of functional requirements—i.e., to characterize the landfill in terms of not only its physical components and systems but also the functions that those systems are intended to serve. Functional requirements of a landfill cover system, for example, can include ensuring no direct contact with waste, preventing water infiltration and contributing to the effectiveness of landfill gas and stormwater management systems. This focus on function will help ensure that the feasibility analysis asks the right questions and explores appropriate PV technologies and alternatives for adapting these technologies in landfill applications.

In addition, it is important to think about PV projects on landfills in terms of an integrated system, not as separate landfill and PV systems. For example, unless PV installation was anticipated when the landfill was closed, the stormwater management system was designed based on the characteristics of the landfill surface in the absence of a PV system. When a PV system is installed, it could affect stormwater volume and discharge patterns. The feasibility assessment should consider whether the original stormwater management system will need to be modified to accommodate the integrated landfill-PV system.

The following sections of this chapter provide an overview of feasibility considerations that are likely to be relevant when conducting preliminary decision-grade and investment-grade feasibility studies of solar projects on landfills. These sections are organized according to key types of feasibility factors, as follows:

- General physical setting – the meteorological setting, solar resource availability, land use and ecological conditions, and transportation and electrical transmission infrastructure at and around the site.
- Landfill technical siting considerations – landfill acreage, characteristics of the landfill site and landfill component systems, institutional controls that affect ability to alter the site and long-term maintenance requirements.
- PV technology – selection and conceptual design of PV system alternatives that match physical setting and landfill characteristics, economic viability of these alternatives, grid interconnection requirements and utility policies (e.g., regarding net metering).
- Community support – level of engagement and support for landfill installation of a PV system, community concerns (e.g., visual impacts) and alternatives for addressing these concerns.

Note that this is not an exhaustive list of feasibility considerations. Project stakeholders should consider whether different or additional approaches are appropriate in light of site-specific conditions.

4.1 GENERAL PHYSICAL SETTING

Typically, one of the first steps in conducting a feasibility analysis is to characterize the general physical setting of the landfill and solar project, including meteorological conditions, land use and ecological conditions and electric transmission infrastructure.

4.1.1 Meteorological Setting

The meteorological conditions (e.g., rainfall, solar radiation, wind speed and direction and temperature) affect the PV system and landfill system performance and design, both individually and in combination. For example, landfill-based PV systems can alter a landfill system's performance by changing the path of stormwater flows and changing exposure to sun and wind, which in turn can impact cap integrity and stability, leachate generation and control systems, vegetative cover and erosion control systems and stormwater management systems. Therefore, to understand the potential impacts of alternative solar project designs, it is important to understand the relevant meteorological conditions and their likely effects on the combined landfill-PV system performance.

There is significant overlap with the meteorological data needed to assess landfill performance and PV system performance. For example, both landfill system performance and PV system performance are affected by global radiation, relative humidity, atmospheric pressure, wind velocity and temperature. For PV systems, these factors affect potential output. For landfills, they affect evapotranspiration, water balance and leachate generation rates.

Rainfall data—both annual rainfall rates and the nature of peak storm events—are important to understand the potential effects of PV system alternatives on the performance of different landfill systems. These data can help identify potential impacts from changes in permeable surface area and ground cover; effects on stormwater runoff and the adequacy of existing stormwater management controls; potential for localized erosion; potential for slope instability due to seepage and/or leachate head effects; and potential threats to nearby aquatic systems such as streams and wetlands.

EPA's Hydrologic Evaluation of Landfill Performance (HELP) model can be used to collect meteorological data and analyze potential effects of PV system alternatives on landfill performance. The model provides access to localized daily precipitation, temperature, wind speed and solar radiation data for the period 1961 to 2014 using the NOAA Climate Prediction Center (CPC) Unified Rain Gauge Analysis and National Center for Environmental Prediction (NCEP) and National Center for Atmospheric Research (NCAR) Reanalysis for the 48 contiguous U.S. states.¹⁷

¹⁷ Access to the HELP model and supporting documentation can be found at: epa.gov/land-research/hydrologic-evaluation-landfill.

Additional data are available from many different sources, including NREL's National Solar Radiation Database (NSRDB);¹⁸ NOAA's National Temperature and Precipitation Maps, Climate Data Online and Advanced Hydrologic Prediction Service;¹⁹ and USGS Average Annual Precipitation (PRISM model) 1961–1990.²⁰

Accounting for extreme weather events is also important when evaluating the physical setting of the solar project. The US Department of Energy (DOE) Office of Energy Efficiency and Renewable Energy (EERE) developed a fact sheet on solar PV systems in hurricanes and other severe weather that provides an overview of Federal Energy Management Program changes to recommended PV system design specifications (DOE 2018). Updates reflect important design, construction, maintenance and operational factors and best practices that can greatly influence a system's survivability from a severe weather event.

Select additional resources developed to address severe weather conditions, storm hardening and resilience include:

- NREL Technical Report on Solar Photovoltaics in Severe Weather: Cost Considerations for Storm Hardening PV Systems for Resilience (Elsworth and Van Geet 2020).
- Rocky Mountain Institute "Solar Under Storm" Select Best Practices for Resilient Ground-Mount PV Systems with Hurricane Exposure (Burgess and Goodman 2018).

4.1.2 Solar Resource Availability

One of the most important factors in evaluating whether a particular site is a good candidate for a PV system is whether the site receives abundant sun most of the day. To be economically viable, PV systems generally require a minimum average solar irradiance of 3.5 kWh/m²/day. However, state or utility incentives or insufficient access to electrical infrastructure may sufficiently improve the economics to enable PV systems in lower resource locations. Figure 4-1 shows the national solar PV resource potential for the United States. This map is intended only to provide general guidance on available solar resource, and site-specific conditions may vary. For this reason, developers typically conduct an individual site assessment for purposes of evaluating and siting a solar system.

Site evaluations typically seek to identify portions of a given site that will receive sufficient sunlight throughout the year. This on-site assessment is generally carried out using industry tools (e.g., Sun Eye or Solar Pathfinder), or one can use simulation software such as SAM, which imports site-specific weather data. These tools and software simulations enable the user to estimate shading, snow coverage and solar access for a given location throughout the year. As a rule of thumb, a site should receive a minimum of 6 hours of sunlight (9 am to 3 pm) on the winter solstice. This baseline typically represents the lowest sunlight exposure for the year, given the seasonal progression of the sun, and is used by the industry as a gauge to assess year-round solar availability for a given site.

In general, open areas, either flat or gently south-facing slopes, are best suited for solar PV projects for maximum exposure to the sun. Depending on landfill design, the areas of maximum exposure could be on the landfill top deck or in buffer zones.

[performance-help-model](#).

¹⁸ The NSRDB provides hourly values of meteorological data for common measurements of solar radiation for the U.S. since 1961 and other parts of the world. For more information and access to NSRDB data, visit nsrdb.nrel.gov.

¹⁹ National temperature and precipitation maps are available from February 2001 to February 2022 at ncdc.noaa.gov/temp-and-precip/us-maps/; climate data, including daily, monthly, seasonal, and yearly measurements of temperature, precipitation, wind, and degree days are available at ncdc.noaa.gov/cdo-web/; and observed precipitation data are available through the Advanced Hydrologic Prediction Service at water.weather.gov/precip/.

²⁰ For average annual precipitation in the contiguous U.S. for the climatological period 1961-1990 developed for polygons using the Parameter-elevation Regressions on Independent Slopes Model (PRISM), see sciencebase.gov/catalog/item/543d4dece4b0fd76af69cbb5.

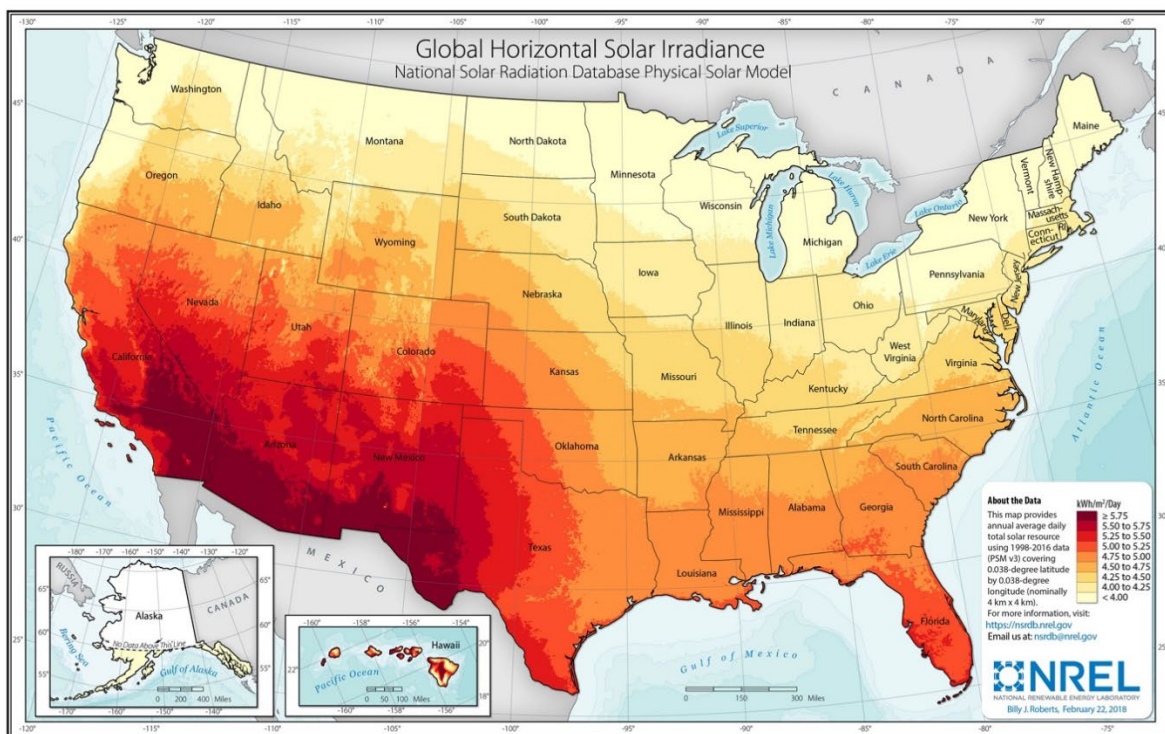

Source: Sengupta et al. (2018)
 Figure 4-1: U.S. PV solar resource (kWh/m²/day).

4.1.3 Land Use and Ecological Conditions

Land use and land cover in the area surrounding a landfill can affect access to solar radiation, as buildings and wooded areas can create obstructions or shading. Land use in the surrounding area also should be considered when assessing visual impacts of project alternatives and associated community acceptability.

In addition to characterizing the built environment in the vicinity of a potential project, it is important to understand its ecological setting. This information will be useful when considering the impacts of PV system alternatives on the natural environment, either directly (e.g., by requiring forest management to maintain access to sunlight, or altering vegetative cover that could serve as habitat) or indirectly (e.g., changing hydrologic conditions and increased erosion and sedimentation in streams and wetlands).

An advantage of developing on and around landfills is that the site is already disturbed, thereby reducing the potential for new negative impacts on wildlife, wildlife habitats and surrounding land uses. Nonetheless, care should be taken to avoid, minimize or mitigate habitat damage. Attempts should be made to locate access roads or new power lines alongside existing rights of way so as not to exacerbate habitat fragmentation. If culverts and stream crossings are necessary, they should be appropriately placed and sized so as not to alter water velocity, collect debris, create barriers to aquatic migration or otherwise change the natural flow of a stream.

When re-seeding after construction or at the end of a project's lifetime, it is preferable to use native vegetation. If possible, flowers that increase pollinator activity will contribute to a more resilient and sustainable local ecosystem. The U.S. Forest Service (USFS) publishes tips for pollinator-friendly landscapes,²¹ and EPA has technical advice for re-vegetating over landfills (EPA 2006). As much as practical, pesticides and herbicides should be avoided. More detail on best practices to reduce the ecological impact of solar developments can be found in reports published by the Maine Audubon Society (Haggerty and Stockwell 2019, Maine Audubon 2019).

²¹ See the USFS Gardening for Pollinators website at [fs.fed.us/wildflowers/pollinators/gardening.shtml](https://www.fs.fed.us/wildflowers/pollinators/gardening.shtml).

4.1.4 Transportation and Electrical Transmission Infrastructure

PV projects on landfills can leverage existing infrastructure, including graded roads and electrical distribution and transmission lines. Existing roads may be sufficient to transport materials required for construction of the solar system as they are likely designed to accommodate large trucks typically used to haul waste to the landfill. Additional access roads may be necessary to support O&M of the PV plant and to comply with local fire and public safety codes.

It is also important when assessing solar projects on landfills to identify the location and to characterize the total and available carrying capacity of electrical distribution or transmission lines near the landfill site. Identifying overall carrying capacity and remaining available capacity of existing infrastructure will be necessary to determine whether the power from a proposed solar project can be added to existing distribution or transmission lines or whether existing lines will need to be upgraded to accept planned and potential future levels of power from the project. Reducing the overall electrical run lengths to the point of interconnection is important to controlling costs. A generally accepted rule of thumb is that the distance to transmission lines should be within 1 mile. However, depending on system size, a longer distance may still yield acceptable economics for the overall system (EPA 2022b).

A grid-connected PV system should also consider whether the site has adequate transmission interconnection opportunities that meet interconnection requirements of the local utility. Many states regulate interconnection of customer-owned power projects. Notably, some states limit the size of a project that can be interconnected or place a grid-wide limit on the amount of capacity that a utility may interconnect. EPA provides resources for Solar Interconnection Standards and Policies as part of the Toolbox for Renewable Energy Project Development.²²

4.2 LANDFILL TECHNICAL SITING CONSIDERATIONS

The following information reviews landfill characteristics that can be relevant when assessing the feasibility of siting a solar project on a landfill.

4.2.1 Acreage of the Site

To reduce the length of DC electrical wiring runs, selecting an area with large sections of contiguous land is recommended. Based on an analysis of existing PV facilities, NREL estimated average land-use requirements for small utility-scale ground-mounted PV facilities of 45 watts ac per square meter (Wac/m²) or 182 kWac/acre for ground-mounted fixed tilt and 39 Wac/m² or 159 kWac/acre for single-axis tracking systems (Ong et al. 2013). These are conservative, direct area estimates and can be used to estimate PV potential based on the area on the landfill site available for siting solar arrays and other PV system infrastructure (e.g., substations and buildings). This is not necessarily the same as the total acreage within the site boundaries. The area necessary for a given system size is highly dependent on the module efficiency and mounting system. In general, a minimum area of 2 acres is recommended for development.

In addition to the top deck, the feasibility analysis should consider the acreage and location of buffer zones and other land associated with the landfill, which in some cases can be significant. Buffer zones are not subject to settlement and allow for more flexibility in choice of PV mounting systems. Buffer zones can also accommodate heavy concrete structures and access roads and, therefore, are more appropriate for siting other PV system components.

4.2.2 Landfill Characteristics

The feasibility of siting solar PV systems on a landfill can depend on landfill characteristics, including closure status, landfill slope and stability, settlement potential, landfill cap characteristics and vegetative cover and other landfill systems, including leachate, landfill gas and stormwater management systems. This section addresses these landfill characteristics in the context of a feasibility analysis.

²² See EPA's Toolbox for Renewable Energy Project Development for resources regarding the interconnection policy landscape and how it could impact project development at [epa.gov/repowertoolbox/solar-interconnection-standards-policies](https://www.epa.gov/repowertoolbox/solar-interconnection-standards-policies).

4.2.2.1 Closure Status and Post-Closure Use

The feasibility analysis should consider whether the landfill and/or targeted area of the landfill is closed and whether the permitted post-closure use included PV system installation and operation. Where the landfill has yet to be closed, opportunities may exist to design the solar project as an integrated component of the overall landfill closure project. Owners or developers considering installation of PV systems on yet-to-be-closed landfills will need to weigh the benefits of designing the PV system as part of the closure plan and the length of time required after the landfill is closed to allow for sufficient settlement prior to PV system installation. Where the landfill has already been closed, the feasibility analysis should consider whether a PV system was included in the closure plan at the time it was approved. If not, the analysis should consider regulatory requirements for obtaining approval of a new post-closure use and implications for PV system design (i.e., consideration of alternatives that maintain the integrity of waste containment and functioning of monitoring systems).

From a design standpoint, a developer will have more flexibility at landfills or units that have not yet been closed, as the landfill and PV system components can be designed in conjunction with one another. For example, when a PV system is being designed as part of the landfill post-closure use, the impervious surface area and surface flow restrictions associated with the PV system can be considered in the design of the stormwater collection and treatment system. Thus, the feasibility analysis might include analyses of trade-offs among different PV system and stormwater system designs. In contrast, if a PV system is being considered on a closed landfill that did not account for this post-closure use, options for reconfiguring the stormwater system might be limited by physical site constraints or permit requirements. The cost of deconstructing and rebuilding stormwater management features could make some options cost prohibitive.

From a regulatory standpoint, the feasibility analysis should consider applicable post-closure permit conditions that could affect the PV system design, requirements for and likelihood of obtaining approval of a new post-closure use and implications for project timing and feasibility. The remainder of this section is devoted to considerations that are generally relevant for feasibility analyses where the landfill has already been closed, PV system installation and operation was not included in the original closure plan, and the PV system would represent a new post-closure use.

4.2.2.2 Age, Waste Composition and Subsurface Reactions

Rates of uniform and differential settlement are largely a function of the composition of the waste material and the age of the landfill cap (El-Fadel and Houry 2000). The rate of settlement will usually diminish over time as voids are filled and the rate of biological decomposition and chemical reactions slow, though settlement rates can increase at later stages due to shifts in biological or other processes over time. In general, landfills that have been closed in recent years will experience higher rates of settlement than landfills that were closed a decade or more ago. Landfill solar developers generally avoid projects on landfills that have been capped for less than 2-3 years due to potential for high settlement rates. Elevated temperature landfills (ETLFs) have many complicated features that can compromise or damage a PV installation and generally should be avoided.

Landfill records can provide information on landfill age, settlement, waste composition and indicators of subsurface reactions. Where records are incomplete regarding past landfill operations, age can be combined with other information (e.g., site visits and field investigations) to provide an indication of landfill construction and waste composition. Knowledge of the age and composition of the waste in the landfill may provide insights into the potential for settlement and other issues that could affect feasibility, design and construction of PV systems on a landfill.

4.2.2.3 Slope and Stability

Analysis of landfill slope and slope stability are critical elements of a PV system feasibility assessment. These characteristics significantly affect the selection of PV technology components, design and layout of solar arrays and energy production potential. Topographic maps, site surveys, site engineering drawings and soil engineering studies (e.g., included in the landfill post-closure plan) typically contain information necessary to complete a slope and stability assessment.

Landfills with minimal grades are often the best candidates for solar development as they simplify the design requirements of a PV system, minimize site preparation activities and costs and can reduce the costs of PV system foundation and structural components. For this reason, the top of the landfill (the “top deck”) is often the best option for siting PV systems on landfills. These areas generally have relatively consistent, shallow grades of 2-3 percent that are designed to remove stormwater, control erosion, prevent ponding and minimize rainwater infiltration. These gradual slopes are ideal for PV system installation, especially when constructed to face south, thereby increasing sunlight exposure.

Many landfills are composed of large mounds of capped waste with steep slopes around the perimeter of the landfill (3:1 slope or 30+ percent grade). Most solar developers place an upper limit of 5-10 percent grades in considering the feasibility of installing a PV system on a slope. Steep slopes represent system design challenges associated with wind loading, erosion and foundation stability and associated higher system installation costs. At the feasibility stage, other options such as PV-integrated geomembranes (see Section 5.2.4) can be considered for steeply sloped areas of the landfill.

The orientation (or azimuth²³) of the landfill slope has a significant impact on energy production potential of a PV system. Slope orientation determines the angles that the sun’s rays hit the PV modules. Developers generally prefer south facing slopes, or those within 20-30 degrees of due south to provide sufficient exposure to the sun over the course of the year. Slope orientations outside of this range typically result in lower annual energy production and can necessitate additional design and system layout considerations to address row-to-row shading issues. Landfill post-closure care requirements typically prohibit adding fill material or regrading the existing slope to provide a more favorable orientation for PV system installation.

Soil stability of sloping areas or side-slope stability is another important engineering consideration. The feasibility assessment should include a review of appropriate soil engineering studies and geotechnical data for the landfill. Of particular importance is consideration of the cap’s ability to withstand construction and long-term operation of the PV system. Installation of solar arrays on steep side slopes can result in side-slope failure if not properly designed.

4.2.2.4 Settlement

A critical element in assessing the feasibility of a landfill solar project is the potential for settlement of the landfill cap. All landfills are prone to settlement. The settlement history, current status and potential for additional settlement should be investigated during the decision-grade feasibility assessment.

Two types of settlement occur in landfills: uniform and differential. Uniform settlement occurs when waste in the landfill decays relatively evenly, resulting in similar or relatively uniform settlement rates over large areas of the landfill surface. Uniform settlement is easier to accommodate in the design and operation of a PV system, though even mild uniform settlement can require changes to positioning and tracking of PV arrays.

Differential settlement occurs when waste decays at different rates throughout the landfill, resulting in uneven surfaces on the landfill cover. Differential settlement may result for a variety of reasons and is often a function of waste material composition. For example, some areas of the landfill may have higher concentrations of organic waste and will be prone to higher rates of decay and settlement than others. Differential settlement can cause movement of PV array anchoring systems and place uneven stresses on mounting systems. This can affect the alignment of the arrays, significantly decrease energy production and cause structural damage to the PV system.

Rates of both uniform and differential settlement are largely a function of waste composition and the age of the landfill and landfill cap. Landfills capped in recent years may experience higher rates of settlement than landfills capped a decade or more ago, though settlement rates can increase at later stages due to shifts in biological or other processes. It is recommended that actual settlement data and other information (e.g., evidence of heating events) be reviewed as part of the feasibility study to assess the relative stability of the landfill and its settlement potential.

²³ The azimuth angle is the compass bearing towards which the modules are pointed.

In some cases, landfill operators may be able to provide forecasts of potential uniform and differential settlement for the landfill. While settlement forecasts are subject to significant uncertainty, they can be useful for assessing overall feasibility and/or identifying areas of the landfill that could be subject to significant future settlement and may not be usable for solar arrays.

4.2.2.5 Landfill Systems

To assess the feasibility of a solar project and evaluate alternative designs, it is necessary to understand the different landfill systems and provisions to be included in the PV system design to ensure that the landfill systems continue to function properly. These systems include the cap/final cover and leachate, landfill gas, and stormwater management systems.

4.2.2.5.1 Cap Characteristics

To assess the feasibility of a solar project and evaluate alternative designs, it is necessary to understand the nature of the cap and the functions that the cap and its components are intended to perform. Units closed under 40 CFR Part 258 Subpart F must meet minimum performance standards for the final cover system or may have an alternative cap designed to meet performance-based standards and approved by the Director of an Approved State (40 CFR §258.60). Figure 4-2 shows a schematic diagram of cover system components that could be encountered at a MSW landfill and are referred to in this document.

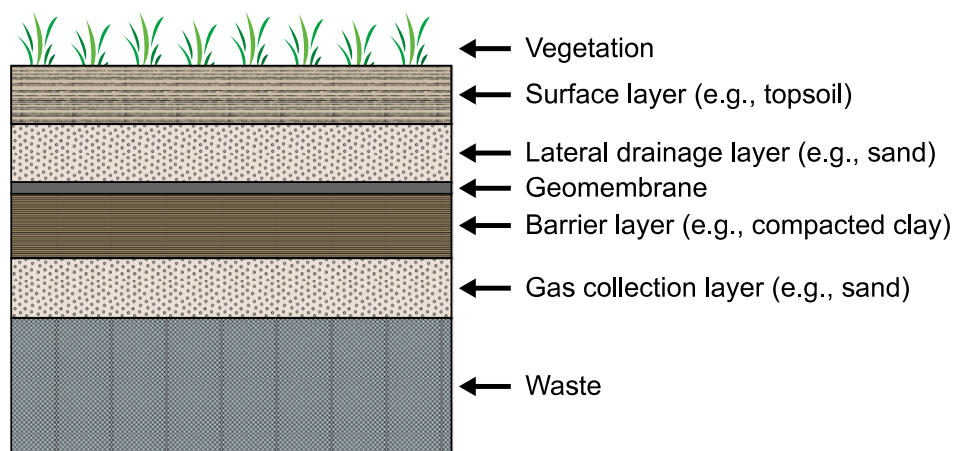

Source: Adapted from EPA (1993)

Figure 4-2: Schematic of possible cover system components.

The functions of the different components of the cover system illustrated in Figure 4-2 include:²⁴

- *Surface layer*, consisting of vegetation and growing medium (e.g., topsoil), the primary functions of which include promoting vegetative growth and resisting erosion by water and wind. The surface layer can also be designed to promote evapotranspiration or satisfy aesthetic and ecological requirements.
- *Lateral drainage layer* designed to collect water infiltrating the surface layer and provide a preferential drainage pathway to drain the water off the landfill cover. This helps minimize percolation of water into the waste and prevent buildup of water above the barrier layer.
- *Barrier layer*, consisting of a geomembrane overlying compacted low permeability soil or clay, designed to impede infiltration of water from the surface into the waste. The barrier layer also impedes gas migration from the waste to the ground surface.
- *Gas collection layer*, consisting of material with high gas transmissivity (e.g., sand), designed to collect gas emanating from the waste and help convey the gas to passive gas vents, active gas wells and/or gas collection trenches.

²⁴ For more information, see EPA (1993) and EPA (2004).

The feasibility assessment should consider PV system designs that will maintain the integrity of the cap and its key functions. This will typically involve consideration of anchoring and mounting systems that minimize or, in most cases, avoid cap penetrations and can accommodate some settlement. It will also include consideration of designs that can work with the erosion control system, as described below. The post-closure permit should be consulted at this phase to identify specific restrictions regarding cap alterations.

4.2.2.5.2 Erosion Control and Vegetative Cover

An erosion control management plan, describing how the surface layer will be protected from erosion, is usually included in a landfill post-closure plan. Vegetative cover is usually a critical component of the erosion-control strategy, designed to absorb precipitation and minimize erosion of the surface layer from stormwater runoff. Precipitation that infiltrates the cover supports vegetative growth, and excess precipitation that percolates through the surface layer is often captured in an underlying lateral drainage layer where it is directed to holding ponds or other suitable containment locations off the cover. By preventing erosion, the vegetative cover prevents exposure of underlying layers of the cover system to the elements.

The decision-grade feasibility assessment should include a review of the erosion control management plan and vegetative cover specifications to help ensure that PV system options under consideration will be compatible with these systems. Certain PV system options have implications for erosion-control management and vegetative cover strategies. For example, PV panels could limit plant growth due to shading and moisture availability (Beatty et al. 2017). This could require changes to the erosion control management plan and vegetative cover strategies, including introduction of vegetation suitable for use under PV arrays, which could require changes to the post-closure plan and post-closure permit. The costs and timing of these changes could impact the feasibility of the project.

If a landfill is developing erosion-control plans and vegetative-cover strategies as part of the closure and post-closure planning process, the owner or operator should consider integrating PV options into those plans. For ballasted or shallow poured concrete footer PV foundation systems, the design and specification of erosion-control measures might incorporate the placement of PV foundations and support structures.

4.2.2.5.3 Leachate and Landfill Gas Management Systems

Landfill leachate is generated when water filters through the waste material and settles near the bottom of the landfill. Typical leachate collection systems include a lateral drainage layer at the bottom of the landfill and network of pipes that conveys leachate from the drainage layer to on-site storage and treatment facilities. Landfill gas is generated by biological and chemical reactions in the waste. Landfill gas collection typically involves the use of gas extraction wells and/or trenches to collect and vent landfill gas or transport the gas to a collection area where it can be flared or scrubbed and used for landfill gas energy projects (EPA 2005).

The feasibility assessment should consider the location and design of leachate and gas collection and conveyance systems, leachate and gas treatment facilities, gas monitoring wells and gas flaring and power generation facilities. The location of these facilities can affect the layout of the PV system to the extent that the PV system may need to accommodate the O&M of piping, collection and monitoring systems. In addition, the feasibility assessment should consider the explosive hazards associated with landfill gas collection, monitoring, storage, flaring and energy generation systems and implications for PV system design and installation. PV system components, including enclosed structures and electrical conduits, should be designed to prevent concentration or conveyance of explosive gas. Use of explosion-proof conduit fittings and other electrical equipment may be required for conduits that penetrate the cap (where allowed) and in other situations where landfill gas creates an explosion hazard.

4.2.2.5.4 Stormwater Management Systems

Stormwater management considerations are closely tied to erosion control and vegetative-cover systems discussed above. Landfill caps are typically designed to allow for surface conveyance of stormwater that is not absorbed by the cap via uniform sheet flow. This is typically accomplished by grading the cap to direct runoff water into stormwater collection areas and to prevent channeling, which can lead to erosion and fissures in the landfill cap.

Stormwater discharges from active and closed landfills are subject to National Pollutant Discharge Elimination System (NPDES) permitting under the Clean Water Act (CWA) as stormwater discharges associated with industrial activity (40 CFR §122.26(b)(14)(v)). These discharges are typically covered by general permits, e.g., EPA's multi-sector general permit (MSGP).²⁵ In general, landfill operators are required to develop and implement a stormwater pollution prevention plan (SWPPP), which describes best management practices (BMPs) and controls to minimize discharge of pollutants in stormwater runoff from these facilities.

To assess the feasibility of a PV system on a landfill surface, it is important to understand these and other applicable storm water management requirements. It is also important to understand how the PV system components could interact with the existing stormwater management system and to limit feasible design alternatives to those that comply with regulatory requirements.

In addition, the CWA requires separate permits for stormwater discharges from active construction. Information should be collected on stormwater permitting requirements during the construction process, as well as O&M requirements of the stormwater management system resulting from the placement of PV modules on the landfill cap. The cost and schedule of stormwater permitting should be assessed as part of the overall decision-grade feasibility assessment.

The landfill operating status may affect considerations associated with stormwater management during the feasibility analysis. If a landfill is not closed, a re-design of the stormwater management system in the existing closure and post-closure plans may be possible to ensure compatibility between the PV and storm water management systems. The construction of a co-designed stormwater management and PV system can save time and money in the long run, even if the PV system is not built until several years after the landfill is closed (i.e., to allow for initial settlement).

In addition, on-site recovery and reuse of stormwater could be considered as a source of PV module cleaning water, if appropriate, especially in regions with limited precipitation or water resources. In this case, a water treatment system could be used to treat the stormwater to the level required to be used for cleaning the PV modules. Refer to Section 7.2 for additional information.

4.2.3 Institutional Controls

Institutional controls (ICs) could be in effect for a landfill and should be considered as part of a feasibility analysis. In general, ICs are non-engineered instruments, such as administrative and legal controls, that help minimize the potential for human exposure to contamination and/or protect the integrity of a landfill.

ICs are typically designed to work by limiting land and/or resource use (e.g., uses of ground water) or by providing information that helps modify or guide human behavior at a site. ICs may also specify requirements for inspections and monitoring (e.g., to ensure that landfill wastes and contaminated media are not migrating from the site).

Examples of ICs that may be applicable to contaminated sites include, but are not limited to:

- Proprietary controls, such as easements or covenants, prohibiting activities that may compromise the effectiveness of the landfill in containing wastes.
- Governmental controls, such as zoning, building codes, ground water use regulations and sports/recreational limits imposed by federal, state and/or local resources and/or public health agencies.

²⁵ Specific applicable requirements may vary depending on whether EPA or the state is the NPDES permitting authority. The MSGP is available in states and Indian country where EPA is the permitting authority. For more information on EPA's NPDES Stormwater Permitting Program, see epa.gov/npdes/npdes-stormwater-program.

- Enforcement and permit tools with IC components, such as landfill post-closure permits that limit certain activities and/or require activities, such as inspections and monitoring, to ensure effectiveness of engineering and/or institutional controls.
- Informational devices, such as deed notices, that provide information or notification to local communities that residual or contained contamination remains on site.

It is recommended that the feasibility study identify ICs applicable to the landfill and evaluate implications for whether a PV system can be developed and/or the usable area of the landfill site and layout of PV system components.

4.2.4 Long-term Maintenance Requirements

Many landfills have specific maintenance requirements to ensure the integrity of the landfill cap and other systems. Maintenance requirements typically go hand-in-hand with inspection requirements and can include, but may not be limited to:²⁶

- Routine maintenance of vegetative cover and re-vegetation.
- Inspection, routine maintenance and repairs to leachate collection and treatment systems, landfill gas collection and treatment systems and stormwater collection and treatment systems.
- Routine inspection and cap repairs.
- Inspection, routine maintenance and repairs to gas, ground water and other monitoring systems.

These maintenance activities generally require access for personnel and equipment to the landfill systems. Similarly, maintenance of vegetated covers may require mower access. Thus, these activities may affect the layout of the PV system and PV system structures.

4.3 PV TECHNOLOGY SELECTION AND TECHNICAL DESIGN

The following sections review information on the selection of PV technology components for landfill applications, as well as the development of a preliminary or “conceptual” system design to assist in the decision-grade feasibility assessment. It also reviews additional feasibility considerations such as predicting the energy output of the system, integrating a battery storage system and assessing the economic characteristics of potential projects.

4.3.1 Matching Appropriate PV Technology to Landfill Characteristics

Once the landfill site characteristics have been reviewed and analyzed for their impacts on the feasibility of a PV system, the next step in a typical decision-grade feasibility assessment is to select appropriate PV technology applications based on site characteristics and landfill system requirements. While the information is presented as sequential steps, it is likely that the process of selecting appropriate PV technologies will be an iterative process that examines trade-offs among technology components.

Often, an initial step is the selection of the type of PV module to be used, which may be based on obtaining the desired system size (kW) within the available land area. Modules are typically evaluated in combination with compatible mounting systems and foundations. Each integrated PV system (modules, mounting system and foundations) is assessed with respect to compatibility with site conditions.

²⁶ For example, see publications at [epa.gov/landfills](https://www.epa.gov/landfills) and [epa.gov/npdes/stormwater-maintenance](https://www.epa.gov/npdes/stormwater-maintenance).

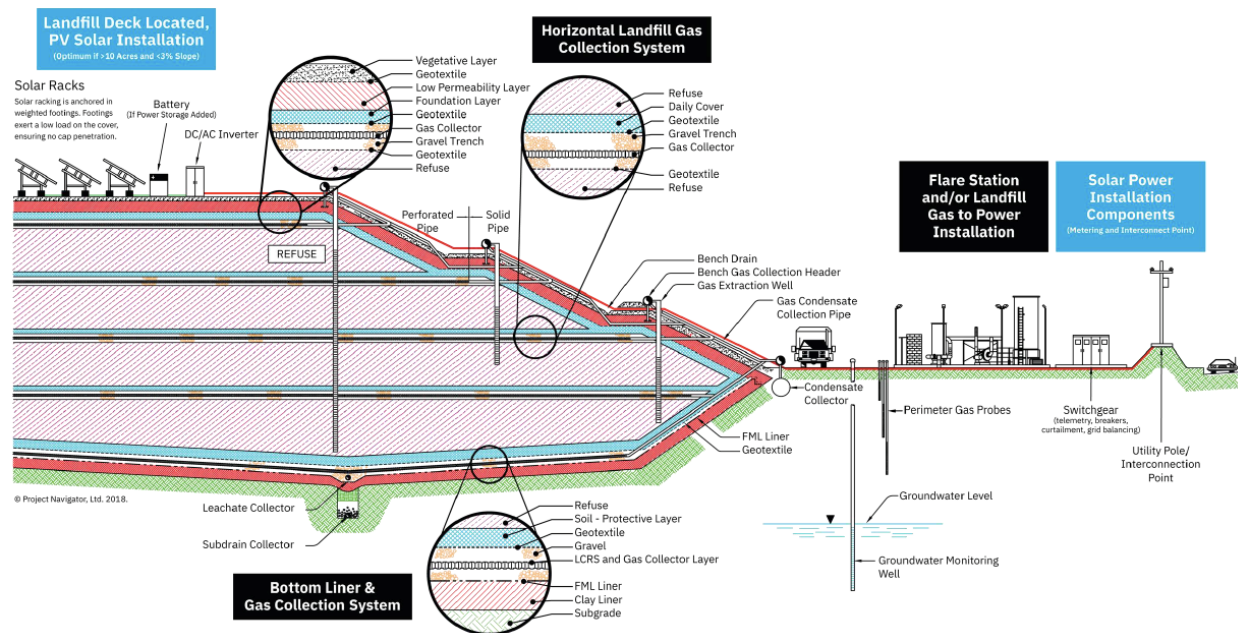

Source: <http://pvnavigatorllc.com/wp-content/uploads/landfill-x-section-with-solar.pdf>

Figure 4-3: Sample solar PV and landfill integrated system design.

When reviewing options for foundation supports the choices are typically ballasted or shallow poured concrete footings. These and other foundation types are described in more detail in Section 5.2.

Next, options for the mounting system and array orientation are evaluated. Typically, fixed-tilt mounting systems are selected for landfill applications. Fixed-tilt systems are typically oriented due south and tilted at an angle equal to or less than the latitude of site location. In some instances, it may be desirable to change the tilt angle to maximize the output for summer production, reduce row-to-row shading impacts and/or allow for more modules to be placed in a fixed area.

Single- and dual-axis trackers are largely avoided on the landfill top deck. Single-axis tracking systems are typically designed with driven pile or post and pier foundations, which are rarely used on the landfill deck because of the possibility of penetrating the cap. Dual-axis trackers usually require large concrete foundations that are too heavy for use on the landfill deck and involve cap penetrations. Tracking systems with ballasted foundations are typically the most viable for this application.

The assessment of anchoring and mounting system alternatives should consider their ability to accommodate landfill settlement potential. Differential settlement of the landfill cap may result in the single- and dual-axis tracker arrays going out of alignment. Even small alignment issues can have significant negative impacts on energy production. Differential settlement can also impact alignment along the tracking axis, which can cause damage to structural members or actuators that rotate arrays to track the sun and, in turn, impact energy production. Options for adjustable foundation and mounting systems that can accommodate some settlement can be considered as well as use of combined or hybrid systems of fixed-tilt arrays on the landfill deck with single-axis tracking systems in landfill buffer zones.

4.3.2 Conceptual Design of Major System Components

Development of a conceptual design of the PV system is usually one of the final steps in a feasibility assessment. Conceptual designs provide an initial estimate and rough layout of PV system components and characteristics but do not involve the level of detail of an engineering design. A conceptual design generally includes the selection and sizing of the potential components of the PV system, a preliminary layout or calculation of the footprint size of the system, and cost estimates.

Conceptual designs typically include the following system components and high-level specifications, some of which may vary depending on location on the site (e.g., landfill deck vs. buffer areas):

- Foundation type: typically ballasted or shallow poured concrete footings.
- Mounting system: fixed tilt, single- or dual-axis tracking.
- PV module type: mono- or multi-crystalline or thin film.
- PV module efficiency.
- Inverter type and efficiency.
- Battery storage integration (optional).

Determining the size of the PV system is a function of whether the system is designed to meet on-site energy needs for a net metering application or whether it is intended to be an exporter of power to the grid. PV systems designed to meet on-site loads can be sized to meet up to 100-120 percent of the annual energy requirements of the facility based on the PV system's projected output on a kWh/kW basis, depending on local net metering laws.

However, if the objective is to size the PV system to be as large as possible based upon the available space, the initial system layout (i.e., preliminary design footprint) may be created to determine the potential energy production for a given site. At a minimum, some preliminary calculations would be necessary to determine the spacing distance between rows of arrays based on module size and system support structure height and to determine how many rows (or partial rows) can fit in the available landfill space (excluding areas previously identified in the site characterization phase that are not suitable for PV). Such calculations will result in an approximate value for the resulting system size based on the objective of maximizing its size based on the available land area suitable for PV development.

As discussed in Section 3.2.4, pairing solar PV systems with battery storage systems can provide significant advantages, including balancing electricity loads, "firming" the solar generation and providing system resilience. Integration of battery storage, such as lithium-ion systems, should be considered early in the feasibility-grade assessment. Resources useful for this assessment include information at EERE's *Solar Integration: Solar Energy and Storage Basics* and *Solar-Plus-Storage 101* websites.²⁷

Another major component of a typical conceptual design is an estimate of the installed cost of the system. There are several ways to obtain cost estimates. The system costs can be estimated based on a comparison to similar projects completed in the region (usually on a \$/W basis), an installer/developer can be contacted and requested to provide indicative pricing, or component manufacturers/distributors and local contractors can be called for price estimates for each component of the system. This last method can be time consuming and may be no more accurate than doing a comparative analysis to other recently completed systems in the area in terms of size, type and application. NREL's *U.S. Solar Photovoltaic System and Energy Storage Cost Benchmark: Q1 2020* may prove useful in the assessment of projects opting to integrate battery storage (Feldman et al. 2021).

Once complete, the conceptual design is generally used to determine the technical and economic feasibility of the project in terms of its expected system output (annual MWh) and economic value metrics such as levelized cost of energy, payback period, net present value and internal rate of return, all of which are discussed in the sections that follow.

4.3.3 Energy Prediction

Based on the siting considerations outlined above, the useable acreage for the PV system can be estimated using aerial maps, drawings or actual measurements from a site visit. Table 4-1 outlines the average land use that can be expected from each type of system and can be used to estimate total system capacity for a ground-mounted system (Ong et al. 2013).

²⁷ For more information, see [energy.gov/eere/solar/solar-integration-solar-energy-and-storage-basics](https://www.energy.gov/eere/solar/solar-integration-solar-energy-and-storage-basics) and [energy.gov/eere/solar/articles/solar-plus-storage-101](https://www.energy.gov/eere/solar/articles/solar-plus-storage-101).

Table 4-1: Average Land use by System Type for Solar PV installations

Technology	Direct Area*		Total Area*	
	Capacity-weighted average land use (acres/MWac)	Generation-weighted average land use (acres/GWh/yr)	Capacity-weighted average land use (acres/MWac)	Generation-weighted average land use (acres/GWh/yr)
Small PV (>1MW, <20M@)	5.9	3.1	8.3	4.1
Fixed	5.5	3.2	7.6	4.4
1-axis	6.3	2.9	8.7	3.8
2-axis flat panel	9.4	4.1	13	5.5
2-axis CPV	6.9	2.3	9.1	3.1
Large PV (>20MW)	7.2	3.1	7.9	3.4
Fixed	5.8	2.8	7.5	3.7
1-axis	9.0	3.5	8.3	3.3
2-axis CPV	6.1	2.0	8.1	2.8

* Direct Area is defined as disturbed land due to physical infrastructure development. Total Area is defined as all land enclosed by the site boundary. Estimated system capacity can be used as one of the inputs for tools to estimate energy production, such as Solar Advisor Model (SAM) and PVWatts. Please refer to Appendix B for additional information on these tools.

4.3.4 Economic Considerations

PV systems will produce energy anywhere there is sun and will produce more where there is a lot of sun. However, economic viability depends not only on the solar resource but also on economic factors pertaining to the site. Economic incentives for PV, such as state renewable electricity requirements with specific solar targets, increase the value of solar-produced electricity. The North Carolina Center for Clean Energy *Database of State Incentives for Renewable Energy (DSIRE)* is a comprehensive source of information on state, local, utility and federal incentives and policies that promote renewable energy and energy efficiency.²⁸

Because landfill sites generally have smaller loads (e.g., a couple of lighting systems or small appliances) when compared to the total PV production, most systems will likely sell electricity through a PPA with the local utility, making collaboration with the utility vital. For sites with larger loads, a “net metering” option through the local utility may be sufficient to drive project economics by offsetting the retail rate of electricity with the production from the PV system. Other key economic factors that can improve a PV system’s viability are high electricity rates or time-of-use (TOU) electricity rates that are high during the sunny parts of the day, solar feed-in tariffs and other solar incentives associated with Renewable Portfolio Standards (RPS) or sales of Solar Renewable Energy Credits (SRECs) and ITC. Public or non-tax paying entities are not eligible for any tax credit-based incentives unlike private or tax paying entities. Additional discussion on financing and deal structures is provided in Appendix C.

Most projects will need to select a financing mechanism, which can be a complex decision since solar projects tend to have long paybacks and necessitate long-term contracts, unless high energy or system repayment costs can be accommodated in the short run.

²⁸ The DSIRE database can be accessed at [dsireusa.org/](https://www.dsireusa.org/).

4.3.5 Interconnection

All grid-connected PV systems require an interconnection agreement, and there are no specific conditions for landfill-based systems. An interconnection agreement specifies the terms, conditions and equipment requirements for a grid-interactive PV system. Interconnection agreements are typically handled through the local distribution utility serving the site.

Although interconnection review processes can differ based on the state, utility, regional transmission organization (RTO) and/or independent system operator (ISO), most processes include the broad steps depicted in Figure 4-4.

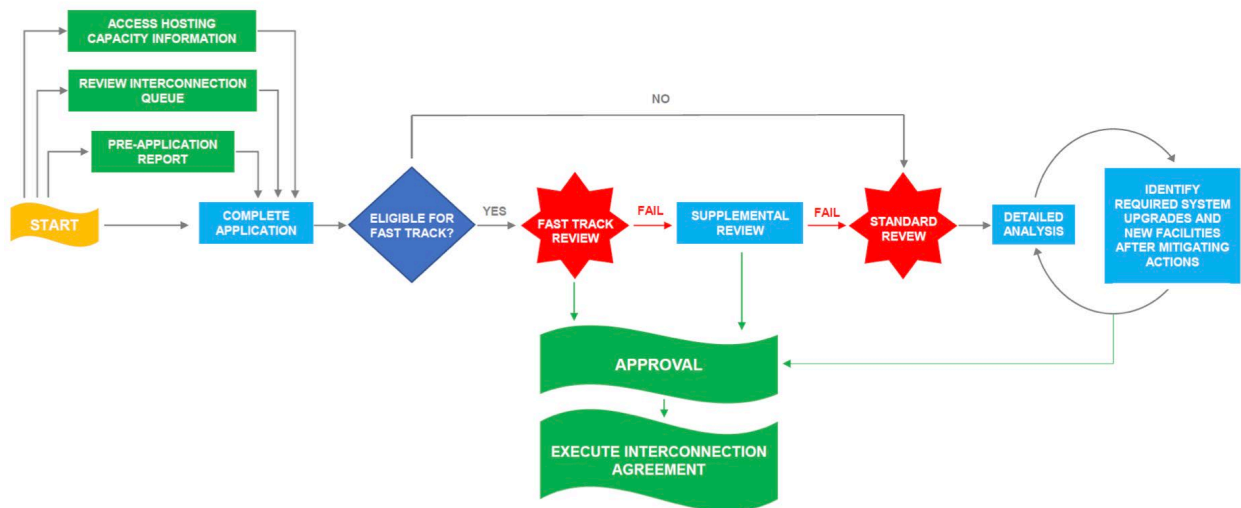

Source: EPA (2019), adapted from Palmintier et al. (2016)

Figure 4-4: Interconnection review process.

Depending on the size of the PV system and the utility processing the interconnection agreement, the interconnection process can be time consuming and incur costs. For net metered systems delivering power on site, the process can be as simple as a one-page contract. For PV systems that are exporting power to the grid, the process is likely to be more detailed and costly. System owners of larger PV systems typically will be required to submit an interconnection application to the local utility, which often includes a nominal fee to evaluate the impacts of the PV system on the local distribution systems.

If the proposed PV system passes the utility's initial screening process, typically a more detailed power flow analysis study will be conducted by the utility with an additional cost to the applicant. Such a study would include an analysis of the impact of the PV system on the utility grid and whether local line upgrades or additional interconnection equipment would be required for interconnection.

Increasingly, utilities are requiring local line upgrades or additional interconnection equipment as part of the interconnection contract approval with the upgrade costs to be borne by the applicant. The entire interconnection review and approval process can take from 6-12 months depending on utility review and analysis periods, and the number of interconnection requests they are processing. During the decision-grade feasibility assessment phase, it is useful to contact the local distribution utility and obtain information on the interconnection application requirements, costs and anticipated review schedule.

4.3.6 Net Metering

Net metering is a utility policy incentive that encourages development of PV and other renewable energy systems by its customers to offset on-site energy requirements. There are several variations among utility net metering policies, but the most common approach allows customers to receive full credit for every kilowatt-hour generated by the on-site renewable energy system. With respect to PV, when the system is generating energy, it offsets the customer consumption behind the meter. If the PV system is generating more energy than the on-site load, then the excess energy is exported to the utility grid and spins the meter backwards, in essence generating a credit or

banking the excess energy with the utility. Then, as the energy generated by the PV system drops below the on-site energy requirements, the credits banked with the utility are drawn back.

Thus, customers receive a one-to-one credit for PV generated on-site whether or not it was consumed by on-site loads at the time of generation. When monthly PV energy generation exceeds the on-site monthly energy consumption, the credits for the kilowatt hours generated are carried forward to the next month. Typically, at the end of the year there is a “true-up” period where the annual energy consumption and PV energy generation are compared. If there is excess generation at the end of the year, options for compensation will depend on the local net metering policy and could include:

- Receive compensation for the excess generation at the utility’s avoided cost of energy (i.e., at a rate significantly lower than the customer’s retail rate).
- Lose the excess generation credit and receive no compensation from the utility.
- Carry the excess generation credit forward to the next year’s billing cycle.

If a net-metered PV project is being considered for a landfill site, it will be important to contact the local distribution utility and obtain a copy of its net metering policy. Net metering policies vary widely, with some being extremely PV-friendly, while others are not.

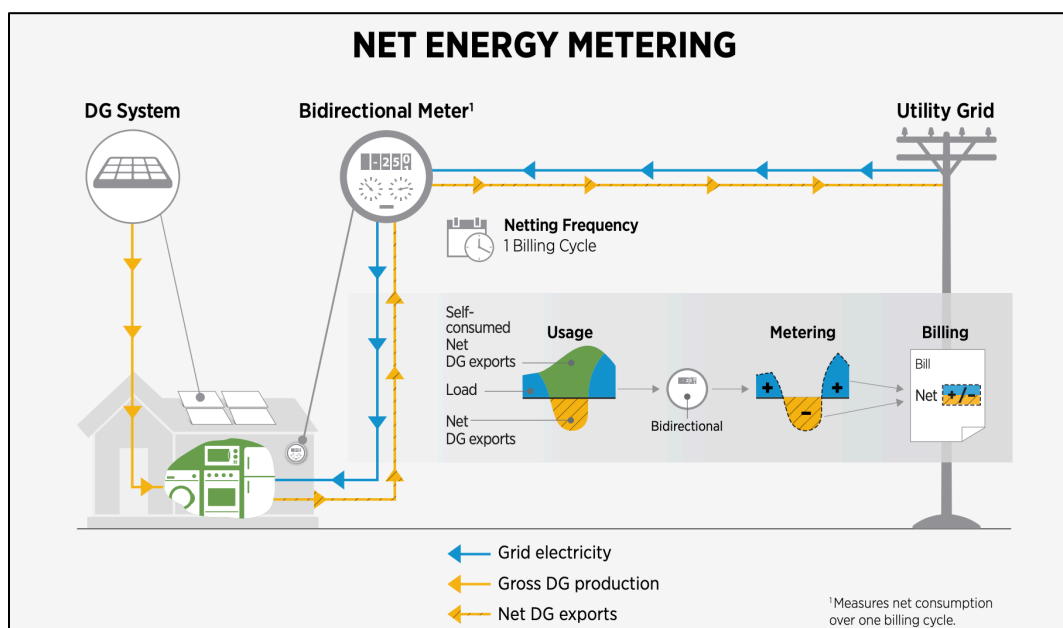

Source: Zinaman et al. (2017)

Figure 4-5: Net metering schematic for a residential PV system.

In the case of a PV system at a landfill site, typically all the energy produced will be exported to the grid.

Net metering is limited to offsetting the energy requirements of on-site loads. In landfill settings, on-site loads tend to be small, consisting largely of leachate sump pumps, landfill gas well pumps and monitoring systems, and ground water monitoring systems. As a result, unless the landfill is part of a larger facility served by a utility master meter, net metered PV systems on landfills will tend to be moderate in size.

4.3.7 Virtual Net Metering

Some states and utilities allow for virtual net metering (VNM) or remote net metering. This arrangement can allow certain entities, such as a local government, to install renewable generation anywhere within its geographic boundary and to generate credits that can be used to offset charges at one or more other locations within the same geographic boundary. Virtual net-metered systems are typically subject to a system-capacity cap, which varies at the state or utility level. Each utility might have their own requirements for system capacity, billing and other system characteristics for VNM which needs to be considered.

As there is typically a mismatch between on-site electrical demands and the potential for PV system size based on usable acreage, VNM may be an important vehicle for many PV systems installed at landfills. In this scenario, the energy produced at the landfill offsets energy consumed by “subscribers” offsite. This arrangement may improve the economic feasibility of the PV project. Refer to the description of Community Solar in Appendix C for an example of virtual net metering.

4.4 COMMUNITY SUPPORT

The following sections present information on additional factors to be considered in assessing the feasibility of landfill PV systems, including identifying the level of community support and/or resistance to a project, engaging the community and considering options for mitigating visual impacts and other community concerns.

4.4.1 Community Engagement and Support

Communities may have a strong interest in the long-term reuse of a MSW landfill. Many community groups may not only want to take part in discussions about solar energy on MSW landfills, but also may want to learn more about solar technology, in general, to provide additional support as community advocates for the project and to provide local insight into specific community needs or considerations. With this in mind, the RE-Powering Initiative promotes reuse of MSW landfills for renewable energy projects when they address community concerns, interests and land use plans. EPA promotes active community engagement in all land revitalization efforts, including reuse of landfills through solar energy projects. Successful community engagement can result in stakeholders identifying new ideas that gain community support, minimize conflict and reduce delays in project completion. See EPA’s Guidance Document *Building Vibrant Communities: Community Benefits of Land Revitalization* for more information on land revitalization and community engagement (EPA 2009). See the RE-Powering training for Addressing Community Concerns for more specific community engagement details and examples.²⁹ EPA’s vision is that the end use of a site should be determined through a combination of a community’s vision, key site characteristics and community assets and should be protective of human health and the environment.

MSW landfills are subject to varying federal, state and/or local regulatory requirements and authorities as is noted in Chapters 1 and 2 of this document. Although the requirements for public notice and involvement may vary, this section focuses on general considerations for community engagement that may be important in siting PV on closed landfills. Clear and transparent community engagement is helpful to carry a project to completion.

Highlight 4-1: Community Engagement Best Practices

Seek input from community stakeholders early and often during project planning and implementation to understand their interests and concerns. It is especially important to provide information about the project in ways that all parts of the community can understand. Here are a few best practices to consider:

- Be ready to explain project design and benefits.
- Seek community input early and often.
- Remember the duration and magnitude of the project's impacts.
- Balance the interests of different stakeholders and be open to compromise that could build community buy-in.
- Recognize some stakeholder interests might not be met.
- Use multiple avenues for communications and engagement.
- See the Solar Market Pathways website for additional strategies, tools, and case studies on their website.³⁰

²⁹ See video training module at www3.epa.gov/swerrims/module6.2/story.html.

³⁰ Solar Market Pathways is an effort funded by DOE to lower the cost of solar energy and accelerate deployment in the U.S. For information on community engagement, see *Expanding Engagement and Participation* at solarmarketpathways.org/innovation/engagement/.

4.4.1.1 Benefits of Community Engagement

Involvement of surrounding communities is important to the success and timeliness of projects, including large scale renewable energy projects such as siting solar PV on MSW landfills. When appropriate, community input about site reuse should be obtained early in a project.

Continued engagement can help to not only inform the community about project plans, but also to gather information about the general setting for the project and ways it can be designed to be consistent with the community vision and benefit the community. Key community stakeholders can share insights into the community's vision as well as potential concerns or issues that community members may have regarding reuse of the landfill. For example, there may be active community groups working to reuse the closed landfill as a park and recreation area, which may not be compatible with a PV installation at the site. Community feedback can help inform and advance the project.

Highlight 4-2: Staying Dynamic and Relevant in the Changing World

Due to changing situations and the need to reach a broad audience, there may be a need to reach communities remotely in addition to or instead of in-person meetings. Information can be relayed to stakeholders and others via:

- Phone calls.
- Virtual meetings.
- U.S. mail.
- Flyers.
- Radio announcements.
- Local media.
- Social media.

4.4.1.2 Openness and Transparency

Open dialogue with the community, actively listening and responding to community concerns or requests, and transparent decision-making processes can help foster proactive relationships between stakeholders and developers. These actions can also help build trust and credibility. Failure to be transparent and open with communities could result in delays or other impacts to project progress.

4.4.1.3 Facilitating Community Engagement

There are multiple ways that a developer can facilitate community engagement on renewable energy projects. During the decision-grade feasibility assessment, developers typically discuss future land use options with local planning authorities, local officials and community members. Directly involving the community through informational and town hall sessions can provide valuable community insight and provide a forum for addressing community concerns. In some cases, community groups may be interested in partnering with the developer (Mitchell and Kovacs 2011).

Communities may be interested in a wide range of topics, which could vary by site and situation. There are usually three main categories of interest: 1) social impacts; 2) environmental impacts; and 3) economic impacts.

Community or stakeholder questions and concerns may include (Hersch 2011):

- What are the benefits or costs of solar energy to the community?
- How does a solar energy system work?
- How does a solar energy system differ from a coal- or natural gas-fired power plant?
- How will solar reuse affect site access?
- What will be the duration of site construction?

- How will the solar system be installed to maintain landfill cap integrity and protect human health and the environment?
- What are the environmental impacts of solar reuse on the landfill?
- Does having a solar installation reduce power reliability?
- How will reuse impact future landfill upkeep and maintenance?
- What are the visual, aesthetic and economic impacts to the site and neighboring communities?
- What are the job opportunities during construction and operation of the solar energy system?

For effective community engagement, the credibility and rapport of the developer's representative can be a critical element to the success of the project. Collaborative partnerships between communities, various stakeholders and developers can facilitate successful reuse and development projects by taking into account community interests and supporting community participation in the decision making process.

4.4.2 Visual Impacts and Mitigation Strategies

Solar PV projects may, at times, raise concerns or face opposition due to perceived or real visual impacts of the arrays and support structures (e.g., related to the type of fencing around the perimeter of facility or the aesthetic impacts of the solar facility on the surrounding community). The feasibility assessment should consider the range of alternatives that are available and could be used to address issues and concerns related to visual impacts of a solar facility. Visualization models can be an effective tool to illustrate how the final installation will appear and can be shared at public meetings or in information flyers. Mitigation strategies can include not using barbed or razor wire on the tops of fencing in areas that are visible to the public or ensuring that security lighting is motion-activated so that the lights are not on all night, thereby disturbing nearby residents. Other mitigation strategies could include building earthen berms or planting trees around the perimeter in such a manner that the view of the solar arrays is blocked from view, balancing this with considerations that the berms or trees do not obstruct the sun's rays from hitting the PV panels.

5. DESIGN CONSIDERATIONS UNIQUE TO BUILDING PV PROJECTS ON LANDFILLS

Specific elements of a solar project are designed to meet specific performance objectives, including the performance objectives of the PV system and the landfill. Information gathered during the feasibility analysis can be used as a starting point for a solar project design.

The following chapter outlines the key landfill characteristics to consider when designing a solar project on a landfill, PV system layout and component system designs, and considerations regarding the integrated landfill-PV system. A summary of the design considerations unique to building PV projects on landfills discussed in Chapter 5 is provided in Chapter 8, Table 8-1. Note that this is not an exhaustive list of design considerations. Project stakeholders should consult landfill engineering and PV system design professionals and consider whether different or additional approaches are appropriate in light of site-specific conditions.

Highlight 5-1: Major Considerations Impacting Solar PV Project Design on Landfills

- Landfill slope, slope orientation and cap characteristics.
- Settlement potential.
- Other landfill systems.
- Selection of PV anchoring system.
- Selection of PV mounting system.
- Selection of PV modules.
- PV system weight and dynamic load considerations.
- Lightning protection and grounding.
- Cover management.
- Stormwater management.
- Integration with landfill gas monitoring and production systems.
- Site security.

5.1 LANDFILL CHARACTERISTICS

Landfill characteristics, including the slope and orientation of the cap, cover system components, settlement potential and other landfill system components, will influence PV system design choices. Where there is significant settlement potential and/or there is little room to modify specific landfill components without compromising their function, these will represent design constraints. Where the landfill surface is relatively stable and/or components can be modified, the PV system designer will have greater flexibility. In all situations, the designer should consider not only the landfill characteristics as they exist prior to construction of the PV system but also how the PV system may alter those characteristics. Ultimately, the design should seek to optimize the performance of an integrated landfill-PV system.

5.1.1 Landfill Slope, Slope Orientation and Cap Characteristics

Characteristics of the landfill cap that will likely influence PV system design choices include:

- Landfill slope and slope orientation.
- Thickness of cap, depth to specific cap components and cap component function.
- Post-closure monitoring, maintenance and use requirements.

These characteristics will affect the selection and design of foundation types, mounting systems, PV module types and usable area for PV system installation. The design of the PV systems should consider how to account for these factors in a way that maximizes the output from the PV system while not compromising the safe, effective and

compliant operation of the landfill. When the PV system is included or was anticipated in the post-closure plan, an integrated system design focused on this objective is possible.

Table 5-1 provides several key characteristics of the landfill cap and their implications for the PV system design. The inter-relationships among cap characteristics and PV system design considerations and choices are discussed in more detail below.

Cap Characteristics	Design considerations
Slope	<ul style="list-style-type: none"> • The top deck of the landfill usually has a relatively consistent shallow slope and is often the best choice for installation of PV arrays. • Steeper slopes are generally avoided. If used, they require special design considerations to avoid increased static and dynamic loadings that could affect side slope stability.
Orientation	<ul style="list-style-type: none"> • Slope orientations outside of +/- 20°-30° from due south typically result in lower annual energy production from the PV system. • Regrading to adjust orientation is generally not allowed on Subtitle D landfills. Sloped areas outside of the optimal orientation range are often excluded from the useable acreage for the PV system.
Cap depth	<ul style="list-style-type: none"> • The depth to the barrier layer (soil or geomembrane) generally will affect selection of compatible foundation types, PV mounting systems and PV module technologies. • Ballasted foundation types are most common, and anchoring systems involving deeper foundations are rarely used on the landfill cap. Fixed-tilt mounting systems are typically used on the cap, and single- or dual-axis tracking systems are usually limited to use in buffer areas.
Cap components	<ul style="list-style-type: none"> • Cap modifications to accommodate the PV system must comply with the closure and post-closure care requirements in 40 CFR Part 258 Subpart F, including requirements that the cap minimize water infiltration and surface erosion. Additional federal, state, local and/or tribal requirements may apply. • Foundation types, design and layout may be limited due to regulatory requirements for the final cover system and/or post-closure permit conditions. • PV system wiring may need to run through above-ground conduits (not underground in the cap) to preserve cap function and/or prevent gas migration. • Where shading and changes to rainfall patterns from PV arrays could affect the vegetative cover, compensating design considerations may be required. • Structures and capacity of stormwater collection systems may limit the layout of PV systems, limit the amount of impermeable area, or necessitate compensating design considerations. • Location and depth of lateral drainage, gas and leachate collection piping can affect the layout of the PV system.

Highlight 5-2: Capping Explored

As Connecticut's Materials and Innovation Recycling Authority (MIRA) prepared to close and cap the 96-acre Hartford Landfill site, the organization began to consider alternative uses for the land. Solar became an early favorite as a potential solution for reuse, as it provided a productive use and potential revenue source for the land. MIRA set about identifying approaches to facilitate solar development. Through research, MIRA found an impermeable synthetic grass cap that would keep the landfill under its state-permitted height restriction of 138 feet and facilitate the installation of solar.

By working with the CT Department of Energy and Environmental Protection, MIRA was able to modify the Hartford Landfill closure plan to allow for phased capping, beginning with sections of the landfill that were already closed. The Hartford Landfill site employed a synthetic cap with three layers: a structured geomembrane, synthetic turf and sand infill. The synthetic turf simulates vegetation, so it still provides run-off protection but requires almost no maintenance. The geomembrane includes studs that offer additional protection in heavy rainfall events. The cap also allowed previously installed environmental protection systems to remain intact, including the site's gas collection system.

HARTFORD LANDFILL AT-A-GLANCE

- Located in Hartford, CT.
- Owned by the city of Hartford.
- Former municipal landfill and (later) waste-to-energy plant from 1940 to 2008.
- 1-MW solar PV installation on approximately six acres of a 96-acre site.
- 3,993-panel solar array.
- Solar power sold to the grid and the city.
- Self-funded by MIRA using tipping fees.
- Solar RECs sold to utilities.

5.1.2 Settlement Potential

Uniform and differential settlement can affect PV system performance, though from a design standpoint, differential settlement represents the greater challenge. Differential settlement occurs when waste material decays at different rates throughout the landfill, resulting in uneven settlement of the landfill surface. It can place stresses on foundation and mounting systems with the potential to impact array alignment, long-term structural integrity of the PV system and energy output. Differential settlement is a particularly important consideration in the design of single- and dual-axis tracker arrays, but even fixed tilt arrays can be negatively impacted by differential settlement. Use of foundation and mounting system designs that can be adjusted to accommodate some settlement is key to successful PV system design on landfills.

In some cases, landfill operators may have conducted forecasts that estimate the potential for uniform and differential settlement. If available, a copy of the forecast should be obtained. While settlement forecasts are subject to significant uncertainty, they can provide preliminary information regarding the potential magnitude of uniform and differential settlement.

The following design factors should be considered when addressing differential settlement:

- PV system component selection.
- Siting of the PV system.
- Engineering measures to mitigate settlement.

A key factor in the selection of PV system components is the ability to adjust mounting systems and other components (e.g., cabling) to accommodate some settlement. With fixed tilt PV systems, differential settlement can impact the alignment of the array and reduce energy production. Mounting systems that can be adjusted to allow for raising or lowering of the array height to correct for the localized differential settlement should be specified where differential settlement is a possibility.

The strategic placement of the PV system on specific areas of the landfill is another design strategy to mitigate the impacts of differential settlement. Areas of the landfill that have been capped for the longest period have likely settled the most and will likely have the lowest rates of settlement in the future. Buffer zones are not subject to settlement. On this basis, PV arrays could be installed in buffer zones and on the oldest capped area first, followed by installation on the next oldest landfilled area and so on.

When designing anchoring and mounting systems for conventional ground-mounted PV systems, the engineer should consider potential effects of these components on localized loading and differential settlement. Localized differential settlement could put stress on piping in the landfill cap (e.g., gas vent and lateral drain piping) and could otherwise affect cap performance.

5.1.3 Other Landfill Systems

The PV system design will need to consider other landfill systems, including stormwater management and landfill gas and leachate collection and treatment systems. The location of system components (e.g., drainage swales, landfill gas and leachate piping and treatment facilities) and the need to maintain the function of these systems and avoid environmental releases may drive PV system design decisions (e.g., mounting system selection and overall layout of the PV system). For example, foundation selection may be constrained to avoid creating preferential stormwater runoff pathways on the landfill surface and changing the water balance in the landfill.

5.2 PV TECHNOLOGY SELECTION AND DESIGN CONSIDERATIONS

5.2.1 Anchoring Systems

Selecting the appropriate anchoring system for the PV array is one of the most critical steps in the design phase, as the anchoring system is the foundation of the PV system and the interface between the PV system and landfill cap. Building upon the information collected and initial decisions made in the decision-grade feasibility assessment, the selection and final design of the anchoring system involves balancing a number of design factors specific to landfills, including system weight requirements, differential settlement and wind and snow loading. In addition, anchoring systems should be designed to incorporate frost and frost heave protection measures in cold weather climates (Solar Power World 2018).

The following types of anchoring systems are commonly used to support PV systems:

- Ballasted systems.
- Shallow poured concrete footers/pre-fabricated concrete footings.
- Concrete slabs.
- Auger or helical pile supports.

Auger or helical pile supports and other anchoring systems involving deeper foundations (driven pile or post and pier foundations) are rarely suitable for Subtitle D landfill applications. These types of foundations would compromise the integrity of the landfill if placed on the cover. Auger or helical pile supports can have applications in landfill buffer zones, as described below.

5.2.1.1 Ballasted Systems

Ballasted systems are the most common anchoring method for PV systems on landfills. A ballasted system is typically composed of a flat tray or large concrete block that is placed on the landfill cap, with the array support structure attached to the tray or concrete block. In tray-based systems, the ballast material—usually pre-cast concrete blocks—are then placed on top of the tray. The weight of the ballast material holds the PV system down and protects it from wind uplift, sliding and severe weather situations.



Source: SunDurance Energy LLC

Figure 5-1: Ballasted anchoring system at Landfill 1A project at New Jersey Meadowlands.

The advantages of a ballasted anchor system are that the system:

- Does not penetrate the landfill cap.
- Requires minimal site prep or disturbance to the vegetative cover.
- Can be installed quickly.
- Can provide good structural support for the PV array.

The key factor in designing a ballasted system is the selection of the proper weight of the ballast material to balance the dead weight loading limits of the landfill cap with the need to protect against wind uplift and horizontal sliding. Some manufacturers offer pre-packaged ballast and racking solutions designed for site-specific conditions. Ballasted systems may be good candidates for flat landfill surfaces but become more difficult to install as the slope of the landfill surface increases.

5.2.1.2 Shallow Poured Concrete Footers and Pre-fabricated Concrete Footers

Shallow poured concrete footers and pre-fabricated concrete footers are similar anchoring systems for PV installations, with the former being constructed on-site and the latter off-site. Concrete footers are set in shallow holes in the landfill cap, hold the mounting system in place and support the load of the PV system. The size and weight of concrete footers are determined by weight bearing characteristics of the landfill cap, as well as by the design criteria established by the wind and snow loading requirements and severe weather considerations. Concrete footers tend to be heavier than other anchoring systems on a pounds-per-square-inch basis, but they provide greater stability (e.g., for applications on steeper slopes).



Source: Oldcastle Precast

Figure 5-2: Precast ballast foundation for fixed tilt PV on a landfill.

5.2.1.3 Concrete Slabs

Concrete slabs have also been used to support PV systems in landfill applications. Slabs are poured on the landfill cap over the area of the footprint where the mounting system will be placed. Once the concrete is cured, the mounting system is bolted to the slab. This configuration allows for more equal distribution of the weight of the PV system across the landfill cap; however, due to the weight of the slab, this anchoring system may result in higher dead weight loads than concrete footers. In addition, concrete slabs are prone to cracking from both uniform and differential settlement, which can result in uneven stress on the mounting system, misalignment of the PV arrays and loss of the uniform distribution of dead weight loading.



Source: NREL

Figure 5-3: Slab foundation for PV system at Boulder, Colorado.

5.2.1.4 Augers or Helical Piles

Augers or helical piles are a type of post support with an auger configuration at the base of the pier. Unlike driven piles that are used in other (non-landfill) PV system applications, augers or helical piles are screwed into the ground typically with the use of a hydraulic torque motor. The advantages of a helical pile anchoring system include quick installation, high stability and structural support, and low cost.

Augers or helical piles are typically not installed on the landfill cap, as they present a risk of piercing the barrier layer and compromising cap integrity, and penetrations of the landfill cap are often prohibited (e.g., in the post-closure permit). This anchoring solution is most applicable for PV system installations in buffer zones.

5.2.2 Fixed Tilt Mounting Systems

PV mounting systems are attached to the anchor system and provide structural support to the racking assemblies and PV modules. As noted in Chapter 3, the most common type of mounting system for landfill applications is the fixed tilt mounting system. As discussed previously, single- and dual-axis tracking systems are not typically specified for use on landfill covers for a variety of reasons and are not discussed in this chapter on design considerations.

Fixed tilt mounting systems consist of structural supports that hold the racking system and PV array at a fixed angle for the life of the system. The angle at which the fixed-tilt system is set is part of the design process and is dependent on several factors. Determining the tilt angle of the mounting system may require a dynamic modeling process to optimize the design based on:

- Economic price signals from the utility or power off-taker.
- Wind and snow loading criteria.
- Row-to-row shading impacts.
- Desired system size and available land area.
- Other site-specific factors.

A general rule of thumb is that the angle of a fixed-tilt system is set to the latitude of the site to maximize annual energy output. However, this rule of thumb is less valid as the latitude increases (i.e., in the northern regions of the United States). Also, it may not always be desirable to maximize the annual energy production from a PV system due to economic or site-specific design criteria. Using a simple model such as PVWatts will assist in determining the optimal tilt angle for a particular site to optimize annual energy production from the system (see Appendix B for more information on PVWatts).

One factor in assessing the angle of a fixed tilt PV system is to review the price signals being sent by the utility or the off-taker of the solar power. If the PV system is net metered, the applicable rate tariff for the site should be reviewed to determine the value of energy being offset by solar production. If the rate tariff is a fixed price per kWh over the course of the year, the tilt angle should be set to maximize annual energy production. If the applicable rate tariff is, for example, a seasonal rate with higher rates in the summer months, consideration should be given to lowering the tilt angle to maximize for summer production (i.e., 10-15 degrees below the latitude of the site). Similarly, if the solar energy is being exported off-site for sale to a utility or other off-taker, the tilt angle should be optimized to maximize the revenue of the system based on the structure of sales price whether that is a flat price for every kWh produced or higher-priced energy during the summer months.

Wind and snow loading also impact the determination of the tilt angle. With fixed tilt systems, higher tilt angles will experience increased wind loading and may necessitate additional foundation support. The impacts of wind loading on systems with higher tilt angles will be multiplied in areas with high wind design speeds. However, wind loading may need to be balanced with snow loading design criteria in areas prone to heavy snow and/or ice loads, and these criteria may be at odds with one another. For example, higher tilt angles may be desired to allow for snow to slide off the panels, but the higher tilt angle could result in increased wind loading on the system and could lead to structural failure.

Another aspect of determining the tilt angle is the row-to-row shading factor. Higher tilt angles result in increased array height. The higher the height of the array, the longer the shadow it casts and the larger the space between rows needs to be to avoid shading of the modules on the row behind it. The distance between rows is determined by the “design day” when the sun is at its lowest angle above the horizon and casts the longest shadow, which is the winter solstice. As a result, higher tilt angles necessitate a larger distance between rows of modules, and lower tilt angles require a shorter distance between rows. The row-to-row shading factor may also be related to meeting PV system size criteria if the objective is to maximize the system size based on the available area of land. Since lower tilt angles require smaller spacing between rows, more PV modules can fit in a finite area of land and allow for larger systems, while higher tilt angles with increased row spacing requirements will reduce the potential system size.

As can be seen from the above discussion, selecting the optimal tilt angle may not be as simple as setting it to the local latitude to maximize the annual energy production of the PV system. Additional factors, such as economic price signals, wind and snow loading requirements, row-to-row shading factors, foundation requirements, and other landfill-specific design criteria need to be assessed as part of the system design process.

5.2.3 Modules

The selection of PV modules to use for a landfill solar process may also require an iterative design review. There are a wide variety of modules available to choose from, requiring a decision-making process to determine the optimal balance among such factors as efficiency, weight and cost. There are three main categories of PV modules, namely mono-crystalline silicon, multi-crystalline silicon and thin film. Silicon-based modules continue to dominate with approximately 90 percent market share, compared to thin-film PV at approximately 3-5 percent (Heath et al 2020). Trade-offs among these types of modules are described below.

5.2.3.1 Mono-crystalline

Mono-crystalline PV modules are the highest efficiency products available on the commercial market, with conversion efficiencies nearing 25 percent under laboratory conditions. Due to their high-power density (power output per unit area), they are particularly applicable for projects where available land is limited and maximizing the overall size of the system is desired. Mono-crystalline panels weigh approximately the same as multi-crystalline panels, but more than thin film technologies except for CdTe thin film modules. Mono-crystalline modules tend to be the most expensive of module technologies on a dollar per watt basis.

5.2.3.2 Multi-crystalline

Multi-crystalline silicon modules are slightly less efficient than mono-crystalline PV but are more efficient than thin film technologies. Lab tests show the efficiency of multi-crystalline silicon modules at 20 percent. Due to decreased multi-crystalline silicon prices (multi-crystalline silicon is the raw material used in manufacturing multi-crystalline PV modules) and increased manufacturing efficiencies, the cost of multi-crystalline silicon modules has dropped considerably over the last several years to a level where they are nearly competitive with many thin film products. While product characteristics vary by manufacturer, multi-crystalline silicon modules may offer a middle ground option for balancing weight, efficiency and cost factors for landfill applications.

5.2.3.3 Thin Film PV Products

Thin film PV products offer a wide range of technology and product solutions. The two technology options most prevalent in the market are amorphous silicon and CdTe products. In addition to these technologies, other thin-film PV modules use copper indium gallium (di)selenide (CIGS) and other semiconductor materials, but these options represent a smaller portion of commercial market.

Amorphous silicon products are available in two forms, modules and laminates. Amorphous silicon has one of the lowest efficiencies in the PV marketplace, with efficiencies of up to 12 percent. They are also the lightest weight modules and may be low cost when compared to the crystalline silicon products. Trade-offs with amorphous silicon modules are that when used in fixed tilt applications, they require additional balance of system (BOS) materials (foundations, support structures, racking systems) due to their low power density. Additionally, they require significantly more land area to achieve the same power output compared to other technologies (i.e., approximately twice as much as a multi-crystalline silicon module system). These factors may significantly outweigh the cost savings seen at the module level when evaluating the overall system cost.

From a weight perspective, due to the additional balance of system requirements, amorphous silicon modules may place more overall weight across the landfill surface, although dead weight point loading will be low compared to other technologies. In addition to module products, amorphous silicon is also available in laminates and is often used in PV-integrated geomembranes (see Section 5.2.4) due to their flexible properties and low cost. Because they are placed directly on the cap surface, these PV-integrated geomembrane laminate solutions do not present the same BOS material concerns as amorphous modules.

The other main thin film technology option is CdTe. CdTe modules have efficiencies of up to 18 percent. The main advantages of CdTe products are that they are some of the least expensive modules available on the market, while offering moderate efficiencies. Like the amorphous silicon thin film modules, CdTe modules require additional BOS materials and typically require additional land area to obtain the same level of power output compared to the crystalline silicon options (although not as much land as the amorphous silicon modules). The biggest concern with CdTe modules in landfill applications is that they are some of the heaviest on the market. Due to heavy module weight, as well as additional BOS requirements, the resulting dead weight point loads could be an issue on landfill caps with low weight bearing capacity.

As illustrated in the above discussion, the choice of PV modules for landfill applications typically involves an analysis of the trade-offs among energy production needs, available area, efficiency, cost and weight, as well as the impacts of various modules on system dead weight loads and overall system costs. The analyses presented above are based on a comparison of general characteristics of the various technologies. When conducting a site-specific design analysis, PV module information should be reviewed based on technology specifications provided by individual manufacturers in terms of product efficiencies, weights and costs.

5.2.4 Other Technologies

Technologies and applications of these technologies are constantly changing and improving. Below are a few other possible technologies that might be suitable for further exploration and/or deployment on landfill applications. As with any technologies and applications being considered or employed, it is important to engage engineers with expertise in landfill engineering, PV design and PV installation to help guide the process and address any issues or special considerations for these technologies.

5.2.4.1 PV-Integrated Geomembranes

A PV-integrated geomembrane is an exposed landfill cover, typically comprising a thermoplastic polyolefin (TPO) material, which can be used in place of a vegetative or other final cover on the landfill. They are typically installed flush with the landfill cover or mounted at low tilt angles (up to 20 percent tilt angle).

A PV-integrated geomembrane is anchored by means of an anchor trenching system. This system is installed by digging trenches in the landfill cap, laying the geomembrane on the landfill cover and into the trench, and, once the membrane has been set to its desired position, placing soil in the trenches. The weight of the soil in the trenches anchors the membrane to the landfill cover. The spacing between trenches is determined by the design wind speed in the geographic area. Horizontal anchors are also used to weigh the system down in areas that are more exposed to the forces of wind and weather.

Highlight 5-3: Integrated Geomembranes

While most solar developers install solar panels on top of the landfill caps using ballasted systems, a few are opting to combine the two.

Developers have used this technology to simultaneously cap and redevelop for solar. For example, in 2009, the Tessman Road MSW Landfill in San Antonio, TX, was the first in the country to use integrated membranes for solar, capping a 5.6-acre section of the landfill to generate 0.13 MW of solar. The integrated membrane cover uses more than 1,000 strips of PV silicon cells to gather solar power (Herrera 2009).

The Hickory Ridge Landfill in Atlanta, GA, followed suit in 2012. The integrated geomembrane cap includes 7,000 solar PV panels over roughly 10 acres of closed landfill, generating 1 MW of solar power (HDR 2022).

PV-integrated geomembranes would usually only be considered when solar PV is included in the landfill post-closure use plan. Post-closure, they would be largely redundant if placed on top of a final landfill cover and/or would require modification of the landfill closure and/or post-closure plan. When designing a PV-integrated geomembrane system, the design should consider cost and energy production of the system compared to that of a conventional final landfill cover and fixed tilt mounted PV system. The design should also consider compliance with applicable regulations, cover stability, ability to withstand and accommodate differential settlement, ability to minimize rainwater infiltration and manage stormwater runoff and special maintenance considerations. Snow removal may be required if moderate- to long-term accumulation builds up over the PV components and impedes energy production.

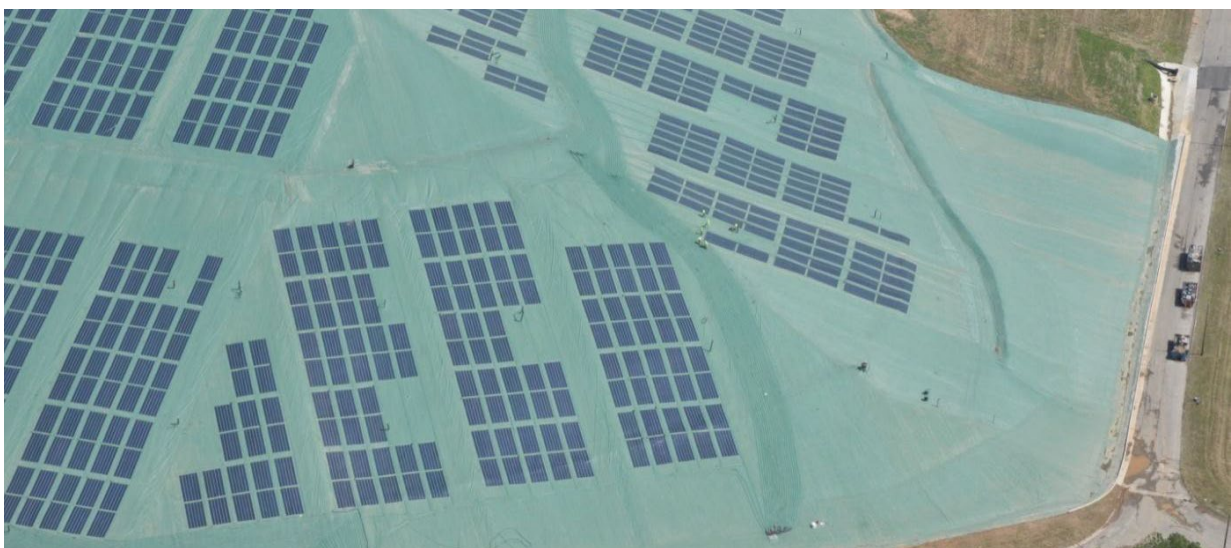

Source: Republic Services, Inc.

Figure 5-4: Hickory Ridge Road Landfill – geomembrane solar cover.

5.2.4.2 Geosynthetic Cover

An alternative to planting vegetation under solar panels is to install an exposed geosynthetic cover or artificial turf. These types of cover systems reduce mowing requirements and provide a setting with less dust, grass clippings and potential for damage to PV panels from mowing equipment. They are also an option in areas where vegetation can be challenging to grow because of water restrictions or extreme temperatures. Exposed geosynthetic covers are distinct from PV-integrated geomembranes. They do not include integrated PV panels and, as such, would require installation of a PV racking system on the cover itself. Several options for exposed geosynthetic and artificial turf covers are available with varying product lifespans.

5.2.4.3 Flex rack Series B - Cast in Place

Cast-in-Place (CIP) systems involve pouring concrete ballast blocks on site and can result in cost savings relative to use of precast blocks. Series B CIP mounting technology has customizable blocks and a two-support system that reduces block thickness. The mounting system's lighter ballasts and array profile flexibility may translate to lower project costs and be more suitable for landfill installation.

5.2.4.4 Ground Mounted Panels

Some companies are exploring completely removing any tracking and racking systems and installing the PV solar modules directly on the ground. This is a relatively new practice; however, proponents of the practice believe this process could save time and money by reducing trenching and cabling requirements and eliminating the need for racking or tracking systems.

5.3 INTEGRATED LANDFILL-PV SYSTEM DESIGN CONSIDERATIONS

The design of the PV system should seek to optimize the performance of an integrated landfill-PV system. Key factors to consider when developing the integrated system design are outlined below.

5.3.1 System Weight and Dynamic Load Considerations

The overall weight of a conventional PV system, as determined by the aggregate weight of the anchoring system, mounting system and PV module, is a key design criterion for landfill PV projects. Based on the weight of the system and the anchoring system design, dead weight point loads (i.e., the force the system weight places on the landfill cover) can be calculated. Dead weight loading of a PV system needs to be compared to the weight bearing capacity of the landfill cover, which is a function of landfill cap depth and design and composition of waste material in the landfill cell. Typically, landfill covers can handle dead weight point loads of up to 7 pounds per square inch (psi), although an upper limit of 5 psi is used by some landfill solar developers.

In addition to the dead weight of PV system components, the design must consider wind and snow loading on the PV systems, including interactive effects of wind loading with various support structure tilt angles and the impacts on foundation structures, as well as the balancing of design criteria between wind and snow loading requirements. PV systems on landfills should be designed to meet the local maximum wind speed design and snow load criteria. One source for determining the design wind speed is the American Society of Civil Engineers (ASCE) ASCE 7 Hazard Tool.³¹

³¹ The ASCE 7 Hazard Tool provides access to information specified by ASCE 7, Minimum Design Loads and Associated Criteria for Buildings and Other Structures, and can be accessed at [asce7hazardtool.online/](https://www.asce.org/hazard-tool).

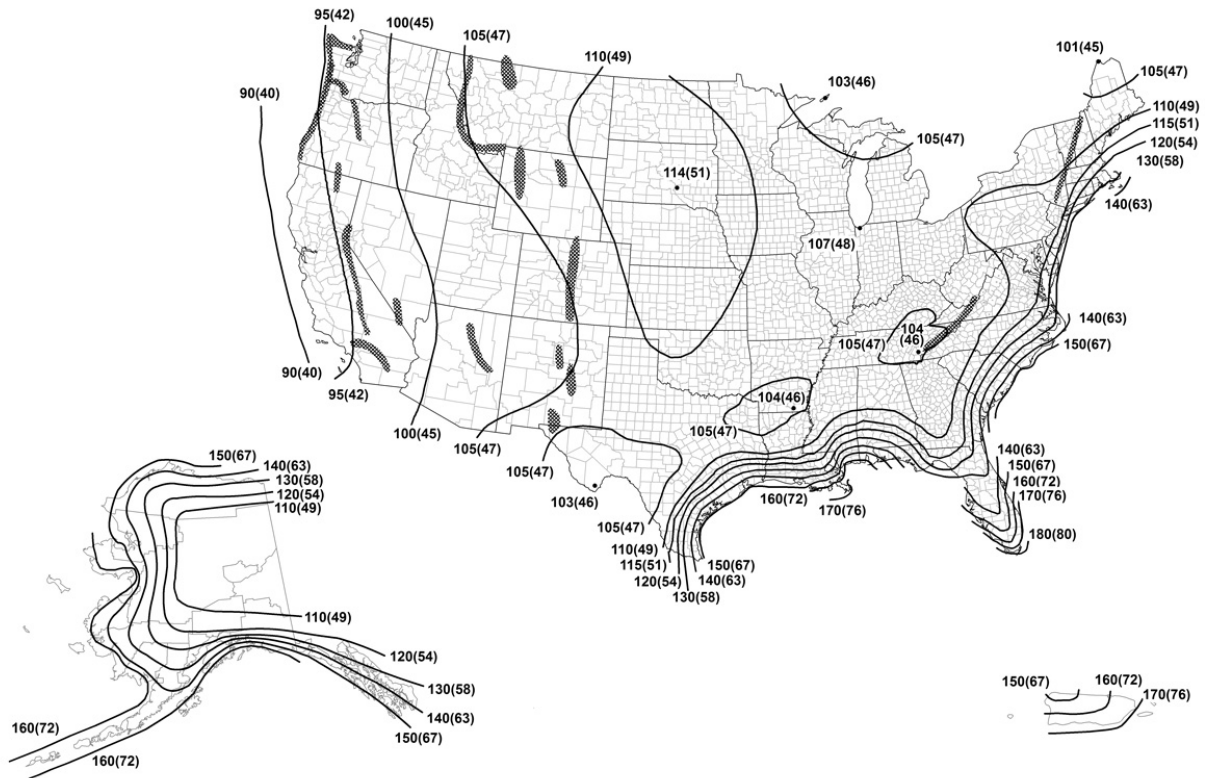

Source: ASCE Standard 7-16

Figure 5-5: Basic wind speed map.

The Medeek Design Inc. online tools allow users to easily obtain the wind speeds (ASCE Wind Speeds™)³² and snow loads (ASCE Ground Snow Loads™)³³ for most locations in the United States. The local building department will also have information on local design wind speeds. Design wind speeds are based on 50-year, 3-second gust speeds, and typically range from 80-120 mph throughout most of the country, with design wind speeds as high as 130-140 mph in hurricane prone regions.

Designing a PV system to local wind speeds requires considerations related to interactive effects of wind loading on PV array tilt angles, structural supports and foundation systems. The design should also consider how alternatives for accommodating wind speed could affect landfill maintenance and snow loading factors. For example, landfill cover maintenance may require raising the arrays higher to allow for access of mowing equipment underneath the panels. Similarly, in areas prone to long-term snow accumulation, the panels may need to be raised 2-3 feet off the ground so that snow does not accumulate on the panels. In both instances, a raised PV array will be subject to higher wind forces and require a design review relative to tilt angle, structural support strength and foundation requirements.

The design should also consider the potential effects of PV system dead weight loads, dynamic wind and overturning loads and snow loads on slope stability. The slope stability assessment should examine the translational and rotational sliding associated with these loads in seismic conditions, as applicable.

³² The Wind Speed Tool can be accessed at <http://design.medeek.com/resources/wind/basicwindspeeds.html>.

³³ The Snow Load Tool can be accessed at <http://design.medeek.com/resources/snow/groundsnowloads.html>.



Source: NREL PIX 54916

Figure 5-6: Snow loading on solar panels.

5.3.2 Lightning Protection and Grounding

Electrical grounding is a standard design consideration for all PV systems. Proper grounding protects the PV system from electrical surges and lightning strikes. The NEC provides safety standards for grounding of electrical equipment (Article 250), as well as specifics related to wiring and grounding of PV systems (Article 690)³⁴.



Source: Alltec's Lightning Protection

Figure 5-7: Lightning protection.

In landfill applications, PV systems should be grounded into the soil either in buffer zones or, if allowed, into the landfill cap material if it is determined that the material and thickness of the cap is sufficient to dissipate the electrical charge. If the PV system is grounded to the landfill cap, grounding rods should not penetrate the landfill cover and protrude into waste material. Penetration of the landfill cap could result in a release of landfill gas, which poses a risk of fire and explosion.

Codes and standards associated with PV system fire prevention and protection are addressed under the International Fire Code (IFC)³⁵ and National Fire Protection Association (NFPA).³⁶ DOE's Office of Electricity Delivery and Energy Reliability (DOE OE) periodically updates a list of codes and standards applicable to energy storage

³⁴ See current edition of NEC at <https://www.nfpa.org/codes-and-standards/all-codes-and-standards/list-of-codes-and-standards/detail?code=70>

³⁵ 2021 IFC Chapter 12, Sections 1205 and 1207

³⁶ See list of NFPA codes and standards applicable to PV systems at [nfpa.org/News-and-Research/Resources/Emergency-Responders/High-risk-hazards/Photovoltaics-Systems](https://www.nfpa.org/News-and-Research/Resources/Emergency-Responders/High-risk-hazards/Photovoltaics-Systems).

systems as part of the DOE OE Energy Storage System Safety Roadmap.³⁷ State and local codes may vary, but localities typically incorporate NFPA standards by reference.

5.3.3 Cover Management

In designing a PV system on an existing landfill, it is important to integrate the PV system with closure plan and post-closure care provisions for maintaining the landfill cap and vegetative cover. For landfills with vegetative covers, the design should consider the potential impact of PV arrays on plant growth due to shading and moisture availability (Beatty et al. 2017). This could require changes to the erosion control management plan and vegetative cover strategies, including introduction of vegetation suitable for use under PV arrays. PV systems should provide for adequate row spacing and should be set at a height to allow access for mowing equipment.

When re-seeding after construction or at the end of a project's lifetime, it is preferable to use native vegetation. Strategies that incorporate natural, low maintenance vegetation and provide desirable habitat (e.g., for pollinators) should be considered as a way of contributing to ecosystem health and reducing maintenance requirements. USDA publishes tips for pollinator-friendly, landscapes,³⁸ and EPA has technical advice for re-vegetating over landfills (EPA 2006).

5.3.4 Stormwater Management

Stormwater discharges from active and closed landfills are subject to NPDES permitting under the CWA and are considered stormwater discharges associated with industrial activity (see 40 CFR §122.26(b)(14)(v)). These discharges are typically covered by general permits, e.g., EPA's MSGP.³⁹ In general, landfill operators are required to develop and implement a SWPPP, which describes BMPs and controls to minimize discharge of pollutants in stormwater runoff from these facilities. The PV project design should consider the interaction between the PV system components and the existing stormwater management system. Depending on the design of the cap, the existing stormwater management system could include, among other controls:

- The vegetated surface layer designed to direct stormwater off the landfill cap.
- A lateral drainage layer above the hydraulic barrier used to collect and drain water that infiltrates the surface layer of the cap and help control infiltration.
- Vegetated and/or rock-lined swales used to collect surface runoff and lateral drainage and convey water from these sources for further control and/or discharge.
- Underground piping and other conveyance system components (e.g., catch basins) used to collect and convey runoff and lateral drainage for control and/or discharge.
- Stormwater detention and retention ponds used to contain and/or control the rate of discharge of runoff and drainage off-site.
- Stormwater treatment systems.

The components of the stormwater management system are often specified in an erosion control plan and vegetative cover strategy in the landfill post-closure management plan. The design basis for the stormwater management system, including design storm and runoff and stage-storage calculations, should be understood before proceeding with the design of the PV project. If this information is not available, it should be reproduced to understand the incremental impact of the PV system on stormwater runoff in accordance with regulatory requirements. Also prior to PV system design, information should be collected on stormwater permitting requirements during the construction process (i.e., NPDES), as well as O&M requirements of the stormwater management system resulting from placement of PV panels on the landfill cap.

³⁷ See, for example, the Codes and Standards Update, Winter 2021, at energy.sandia.gov/wp-content/uploads/2021/02/SC-Report-by-SDO-WINTER-2021_Final.pdf.

³⁸ See the USFS Gardening for Pollinators website at fs.fed.us/wildflowers/pollinators/gardening.shtml.

³⁹ Specific applicable requirements may vary depending on whether EPA or the state is the NPDES permitting authority. The MSGP is available in states and Indian country where EPA is the permitting authority and has made the permit available for coverage. For more information, see epa.gov/npdes/stormwater-discharges-industrial-activities-epas-2021-msgp. Landfills are classified in Sector L of the MSGP.

In addition to the requirements for stormwater discharges from the landfill, the CWA also requires separate permits for stormwater discharges from active construction. PV system design should consider requirements associated with NPDES stormwater permitting, in addition to stormwater management during the O&M phase.

In most cases, the PV system will affect the operation of the stormwater management system. The PV system will increase the impervious surface area of the landfill and will create localized changes in rainfall infiltration and runoff patterns. The magnitude and nature of these impacts will depend on the meteorological setting and specific landfill and PV system characteristics. The following should be considered when designing the PV project:

- Overall and localized changes in rates and timing of stormwater runoff during design storm events and capacity of existing drainage systems, including the drainage layer, swales, piping, ponds and treatment systems (e.g., constructed wetlands, tanks) to effectively direct, contain and treat the runoff.
- Localized effects of PV arrays and foundation systems on rainwater infiltration, surface flows patterns, vegetation, potential erosion and the functioning of the vegetative cover and drainage layer.

Where system-wide and/or localized changes are predicted, changes to stormwater management systems to meet landfill permit and other local, state and/or federal requirements for runoff control and discharge requirements should be included in the design of the integrated landfill-PV system. Design considerations could include construction of drainage features to collect and direct runoff from PV foundations and arrays, resizing drainage swales and/or relining drainage swales to control erosion, resizing detention and retention ponds, and resizing and/or upgrading stormwater treatment systems.

If a landfill is in the closure process, the stormwater management system for the closed landfill can be designed in tandem with the PV system to ensure compatibility of both designs.

5.3.5 Integration with Landfill Gas Monitoring and Production Systems

The PV system should be designed to ensure that the system layout is compatible with existing landfill gas collection, monitoring and generation systems. PV system components, including enclosed structures and electrical conduits, should be designed to prevent concentration or conveyance of explosive gas. Use of explosion-proof conduit fittings and other electrical equipment may be required for conduits that penetrate the cap (where allowed) and in other situations where landfill gas creates an explosion hazard. In addition, PV systems should be designed to avoid the need for heavy maintenance vehicles or equipment in areas where the equipment could damage above ground facilities or create differential settlement that could damage below grade piping associated with the gas collection system.

If the landfill includes an on-site landfill gas-fueled electric generation facility, consideration should be given to whether the two systems will operate separately or as a hybrid system. Typically, PV and landfill gas generation units are operated independently and in isolation from one another. In these cases, consideration should be given to electrical metering requirements, particularly if power from the two systems is being exported through the same interconnection point. If the PV system is planned to be net metered, this can be problematic, as utilities will generally not allow a PV system to be net metered when an independent power producer (i.e., landfill gas generator) is on-site and exporting power to the grid. In these instances, it will be necessary to work with the local utility to determine whether a new interconnection point will be required for either the net metered PV system or the landfill gas generation, or whether sub-metering options are available to account for each source of generation.

Solar PV and landfill gas-powered electric generating units can be operated as a hybrid system. This strategy can maximize the economic value of both systems and eliminate some concerns over sub-metering and interconnection requirements. With a PV/landfill gas hybrid system, the landfill gas generation can be used to “firm” or shape the output of the solar power system. For example, if the PV system output drops during the day, the landfill gas generation can be ramped up to compensate for the drop in PV output. The output of the hybrid system can also be shaped to match the needs of local utilities, if power is sold to them and capture a higher sales price due to the ability of the hybrid system to provide firm power when it is needed. If a landfill gas-to-energy unit is already operational on-site, this strategy would likely reduce the interconnection requirements and costs of a PV-only system, as much of the interconnection equipment and permitting requirements would already be in place.

Additionally, as landfill gas production decreases (i.e., as biological processes slow down as the landfill ages), more PV can be deployed to take advantage of existing transmission capacity at the site. Utility approval would still be required for interconnection of the PV system, but it is typically easier to have an existing interconnection agreement reviewed for additional capacity than it is to apply for a new interconnection agreement.

5.3.6 Site Security

Security concerns also should be addressed in the design phase of a solar project to protect against the threat of theft and vandalism and to prevent unauthorized entry into the area by individuals who could be exposed to safety hazards resulting from the presence of high voltage equipment. For example, some landfill locations may be popular destinations for ATV and snowmobile riders, and they should be kept out of the area containing PV arrays for their own protection and safety. The most common, and often required, security measure is perimeter fencing around the footprint of the PV system. Design criteria of fencing systems include type, height and required set-back distances from the solar arrays. Some solar project sites also employ the use of security cameras. Security lighting is typically not employed as security measure, as they consume a significant amount of energy, and they may face opposition from local residents due to visual impact concerns. However, the use of motion-activated security lighting along the fence perimeter may warrant consideration.

5.4 FINAL PV SYSTEM ENGINEERING DESIGN AND LAYOUT

The final phase of the design process is to develop an overall PV system design and layout based on the types of design considerations presented in this chapter. The first step of this process is the PV system design based upon the selected components. Weighing such design factors as site characteristics, regulatory requirements and preferred characteristics of system components, the final technology components are selected and integrated into the design. The design typically includes schematics of the integrated system (foundations, racking, modules). Once the schematics of the integrated components are complete, the basic characteristics of the array are known, e.g., array height and row length. This then serves as the basis for the site layout.

The next step in the design process is to create a system layout. The layout is based on the development of a footprint for the PV system based on areas determined to be suitable to build on, as well as areas identified to avoid due to existing landfill gas/leachate systems, steep slopes and other site-specific requirements. Then, typically starting with oldest capped area of the landfill within the PV system footprint, the rows of PV arrays are laid out in the desired orientation. Then, allowing for the required spacing between rows based upon shading and PV system and landfill cover maintenance access requirements, adjacent rows are laid out within the footprint until the desired system size is achieved, or the footprint is maximized.

This is a simplified description of the engineering design process and is presented as a framework for how PV technology components are selected and the considerations that factor into the overall layout of a system on a landfill property. Additional civil engineering design work will be required for site preparation and anchoring system design, and additional electrical engineering design work will be required for wiring schematics, code compliance, inverter placement and interconnection equipment design and specification, integration with system monitoring equipment and other electrical design elements. Qualified landfill and PV system engineers will need to be consulted to complete site-specific engineering design.

6. CONSTRUCTION CONSIDERATIONS UNIQUE TO BUILDING PV PROJECTS ON LANDFILLS

The following chapter discusses site preparation and grading, protection of landfill components and other site-specific aspects to be considered before starting construction of a PV system on a landfill. A summary of the construction considerations unique to building PV projects on landfills discussed in Chapter 6 is also provided in Chapter 8, Table 8-1. Note that this is not an exhaustive list of construction considerations. Project stakeholders should consider whether different or additional approaches are appropriate in light of site-specific conditions.

Developers should contact the appropriate permitting authority to discuss proposed modifications to an existing cap or planned cap design and to determine associated permitting requirements. Developers will need to obtain all necessary permits and/or permit modifications before starting construction. In addition, financial assurance to cover costs may need to be adjusted if changes are made to the closure plan or post-closure plan.

6.1 SITE PREPARATION AND GRADING CONSIDERATIONS

Construction of a PV system on a closed landfill will require site preparation and may require grading. Site preparation and grading may include removal and replacement of vegetation and topsoil and/or excavation to prepare the site for setting foundations and to address modifications to other landfill systems (e.g., to create/reconstruct stormwater collection swales). It could also include the construction of temporary access roads and staging areas for PV system materials and equipment, construction vehicles and other construction equipment. Staging areas and access roads should be located to not interfere with landfill operation, inspection/monitoring and maintenance activities. Access roads should be designed to avoid impacts to the functioning of the landfill cap, steep slopes and other systems by limiting the travel of heavy equipment to specifically designated areas.

Highlight 6-1: Major Construction Considerations for Building PV Projects on Landfills

- Site preparation and grading requirements and constraints
- Avoidance of penetrating landfill cap
- Avoidance of landfill gas monitoring, piping and production equipment
- Dust control
- Stormwater management
- Site security

In most cases, post-closure permits will restrict the placement of fill and/or the operation of heavy vehicles and other construction equipment on the landfill cap. Where allowed (e.g., to create a uniform surface for PV system foundations), grading should be done in a controlled and approved manner. Where new fill is allowed and placed on the landfill cover, the possibility of secondary settlement should be considered in the engineering design and a period to allow for settlement may be required. A slope stability assessment should be conducted prior to placing fill or conducting grading activities on the landfill cap.

Grading of the landfill cap must comply with applicable federal, state and/or local closure, post-closure and other requirements. For landfills that are regulated under 40 CFR Part 258, any modifications to the cover system must comply with the requirements outlined in 40 CFR Part 258 Subpart F. Among other things, final grading must meet minimum final cover requirements or, for alternative final cover designs, be approved by the Director of an Approved State, as defined under 40 CFR §258.2. In addition, all modifications to the final cover system must comply with post-closure care requirements under 40 CFR §258.61. Note that additional federal, state, tribal and or/local requirements may also apply.

Areas exposed by site preparation and other construction activities (e.g., areas with new fill or where the topsoil or subsoil has been exposed) should be stabilized and managed to minimize erosion in accordance with post-closure care and NPDES permitting requirements (see Chapter 5).

6.2 PENETRATIONS OF THE LANDFILL CAP

In general, post-closure penetrations of the landfill cap are not allowed and should be avoided. Cap penetrations at MSW landfills are typically limited to those required for gas extraction wells and are included in the final cover system design and construction. These penetrations are specially designed to prevent uncontrolled migration of methane and other landfill gases to the surface by isolating penetrations from the final cover system. Typically, this is achieved through an engineered combination of membrane layers, gas-venting layers and other layers designed specifically to block potential gas pathways near penetrations in the final cover system.⁴⁰

Post-closure care requirements under 40 CFR §258.61(a)(1) call for maintaining the integrity and effectiveness of the final cover, while 40 CFR §258.61(c)(3) requires that post-closure use of the property not disturb the integrity of the final cover. In the unusual situations where penetrations associated with the installation of a PV system are approved by the local permitting authority, they should be designed and constructed using the specialized techniques employed for gas extraction wells. The landfill will continue to be subject to applicable regulatory requirements under 40 CFR Part 258 and/or other federal, state, local and/or tribal requirements after PV system installation.

6.3 AVOIDANCE OF LANDFILL GAS MONITORING, PIPING AND PRODUCTION EQUIPMENT

As discussed in previous sections, the PV system should be designed to avoid landfill gas monitoring, piping and production equipment and ensure the long-term effectiveness and safety of these systems. Any temporary enclosed structures installed at the site should be monitored for explosive levels of landfill gas. During construction of the PV systems, strict site control should be maintained to prevent inadvertent damage to these systems and to avoid hazardous situations (e.g., potential sparking near landfill gas). Site control can be maintained by fencing or otherwise restricting access to areas containing gas monitoring and control equipment and areas where construction personnel could be exposed to elevated gas concentrations. In addition, clearly designated access roads should be established to limit the movement of construction vehicles and equipment.

6.4 DUST CONTROL

Dust control is typically a requirement for all ground-mounted PV systems during the construction process, particularly during the site preparation and grading phase. Dust control is usually accomplished with the use of water trucks that spray recently disturbed ground to prevent winds from dispersing loose fine dirt throughout the area. While the use of water trucks for dust control is a common practice during most construction activities, standard water trucks may be too heavy for the load-bearing characteristics of the landfill cover. The use of overly heavy water trucks can result in excessive live loads and pose a threat to landfill drainage and gas collection systems.

⁴⁰ See EPA (2004) and EPA (2005)

6.5 STORMWATER MANAGEMENT

Stormwater discharges from construction activities disturbing one or more acres of land are generally subject to NPDES stormwater permitting requirements (see 40 CFR §122.26(b)(14)(x) and (15)). Construction site discharges are typically permitted under general permits, e.g., EPA's Construction General Permit (CGP).⁴¹ In general, construction site operators are required to develop and implement a SWPPP, which describes BMPs and controls to minimize discharge of pollutants in construction stormwater discharges. These sites and smaller sites may be subject to local stormwater control requirements as well.

In addition, in some cases, components of the landfill stormwater management system under its industrial stormwater permit will be temporarily impacted by the installation of a PV system. Site preparation could remove vegetation and temporarily expose soil to rainfall prior to construction of overlying structures and/or final stabilization of the area.

Overland flow and swales could be temporarily interrupted by the staging of construction materials and equipment and by temporary excavations, rutting or access roads. Controls should be put in place and maintained to prevent excess erosion and permanent damage to these systems and the surrounding environment. When the installation of the PV system requires modification to the stormwater collection system, construction should follow engineering specifications and good construction practice, including specifications for trenching, inverts and elevations, materials (e.g., rip rap, drainage matting, stormwater piping), bedding requirements, etc. Standards for good construction practice have been developed by the American Society of Civil Engineers (ASCE 2006, ASCE and WEF 1992) and may also be specified in state and local rules and regulations.

Construction equipment used for modifications and/or installation of stormwater management systems and the operation of construction equipment should conform to engineering specifications designed to prevent excess live loads on the landfill cap and compaction. As with other construction activities, erosion controls should be installed and maintained according to engineering specifications and local, state and/or federal requirements.

Construction of stormwater management systems should be inspected and overseen by a competent inspector and engineer and testing of materials and installed systems should meet specified requirements. Modifications to the original design to address unforeseen field conditions should be reviewed with the design engineer and government personnel with oversight authority.

6.6 SITE SECURITY

As with any construction project, the threat of theft and vandalism is a major concern, and security safeguards should be employed to protect against those threats. Since a security fence will be required around the perimeter of the final installation, it is recommended that the permanent fence be erected early in the construction process and prior to the delivery of PV panels and other balance of system equipment. In many cases, the landfill may already have a security fence in place, negating the need for a new fence to be erected.

The project developer should consider the use of temporary lockable storage sheds to secure valuable PV system equipment prior to installation, as PV panels and copper wire spools are an easy target for thieves. If theft or vandalism is of particularly high concern, the developer may want to consider hiring a security patrol during the construction process.

⁴¹ Specific applicable requirements may vary depending on whether EPA or the state is the NPDES permitting authority. The CGP is available in states and Indian country where EPA is the permitting authority. For more information on the CGP, see [epa.gov/npdes/2022-construction-general-permit-cgp](https://www.epa.gov/npdes/2022-construction-general-permit-cgp).

7. O&M CONSIDERATIONS FOR PV PROJECTS ON LANDFILLS

The following chapter outlines the types of long-term actions (e.g., adherence with post-closure plans, water management, panel cleaning) that should be taken to ensure continued safe and effective operation of the integrated landfill-PV system once it is installed. Routine O&M of PV systems are usually minimal in cost, ranging from \$10-15/kW on an annual basis. A summary of O&M considerations for PV projects on landfills discussed in this chapter is also provided in Chapter 8, Table 8-1. Note that this is not an exhaustive list of O&M considerations. Project stakeholders should consider whether different or additional approaches are appropriate considering site-specific conditions.

7.1 ADHERENCE WITH LANDFILL POST-CLOSURE O&M AND MONITORING PLANS

Following the installation of the PV project, continued compliance with the landfill post-closure plan, including any approved modifications to the plan to accommodate the PV system, is required. Following installation of the PV system, opportunities should be sought to integrate landfill and PV system O&M and monitoring requirements. For example, routine cap and PV system inspections could be conducted at the same time and certain equipment maintenance and/or material supply contracts could be combined.

In addition, opportunities for combining maintenance scheduling and operational monitoring data systems could be explored, not only to identify operational efficiencies but also to enable integrated analysis of monitoring data. For example, settlement and PV production output data could be combined and analyzed to determine possible interactions between cap settlement and output. Such systems could be used to identify and/or rule out potential sources of operational inefficiencies and enable appropriate responses.

Highlight 7-1: Major Construction Considerations and Best Practices

- Adherence with landfill post-closure O&M and monitoring plans.
- Panel washing and water management plan or natural cleansing.
- Stormwater management.
- Vegetation and cover management.
- System monitoring and troubleshooting.

7.2 PANEL WASHING AND WATER MANAGEMENT PLAN OR NATURAL CLEANSING

The washing of PV panels is the main routine maintenance activity undertaken for PV systems. Removing dust and silt from the PV panels increases their performance and may be required on a periodic basis, depending on the frequency of rainstorm events at a given site. In some areas of the country that receive frequent and abundant rainfall, there is not a need to wash the solar panels as they are cleansed naturally. In drier areas of the country, and during times of drought, panel washing may be required. In determining the need to wash panels, it may be beneficial to perform a benefit-cost analysis to compare the estimated reduction in PV system output without panel washing to the cost of washing panels (primarily labor costs). In some cases, PV system owners find it is more cost effective to rely on natural cleansing than to pay for panel cleaning.

Panel washing is water-intensive, and the use of water to clean panels may not be allowed in some water-constrained jurisdictions. However, particularly in landfill applications, PV module washing should not use cleaning fluids that contain harmful chemicals, as these chemicals could leach into the landfill cover and underlying layers, and/or may runoff during stormwater events. Attention should also be given to the weight of water trucks on the landfill if water-based cleaning is used and there is no on-site water available.

7.3 STORMWATER MANAGEMENT

Routine and corrective maintenance of stormwater management systems will be required to ensure that they continue to meet aesthetic and functional requirements. Aesthetic maintenance can include grass trimming in areas around stormwater management components, weed control, etc. Functional maintenance can include preventive maintenance (e.g., maintenance of vegetative cover, removal of sediment from swales and ponds, maintenance of mechanical equipment) and corrective maintenance (e.g., erosion and embankment repairs and mechanical equipment repairs) (Livingston et al. 1997).

7.4 VEGETATION AND COVER MANAGEMENT

In landfill solar applications, the maintenance of the landfill cover is typically negotiated in the contract between the system owner and landfill owner. In some instances, maintenance is the responsibility of the PV system owner, and in others the responsibility falls to the landfill owner. Cover maintenance activities typically consist of periodic mowing of the vegetative cover, regular cap inspection and, when necessary, cover repair. Typically, inspections are conducted on a quarterly or half-yearly basis to look for cracks or fissures in the cover material, erosion or channeling from stormwater runoff, depressions and evidence of ponding, or other evidence of differential settlement. If damage to the cap is identified, it is repaired, and the source of the damage is corrected.

7.5 SYSTEM MONITORING AND TROUBLESHOOTING

Most PV systems come equipped with remote monitoring systems to allow the system operator to monitor the system's performance. Often, weather stations are installed at the site. The stations capture several parameters including solar irradiance, temperature (ambient/panel), wind speed/direction and precipitation. These parameters are used to compare predicted system output and the actual output of the system. This allows for identification of problems with the system if the actual output is less than predicted. In addition to weather stations, infrared (IR) scans using drones are used to detect emitting heat, solar irradiance and any manufacturing defect, damage, temporary shadowing, defective bypass diode and faulty interconnections. Typically, the larger the PV system, the more complex the monitoring system becomes, as it becomes more important to identify modules or strings of modules that are underperforming in a timely manner. PV monitoring systems are useful for providing real-time cumulative data on system performance that can be used in public displays, such as kiosks, to highlight a project to the local community. Figure 7-1 shows examples of remote monitoring approaches.

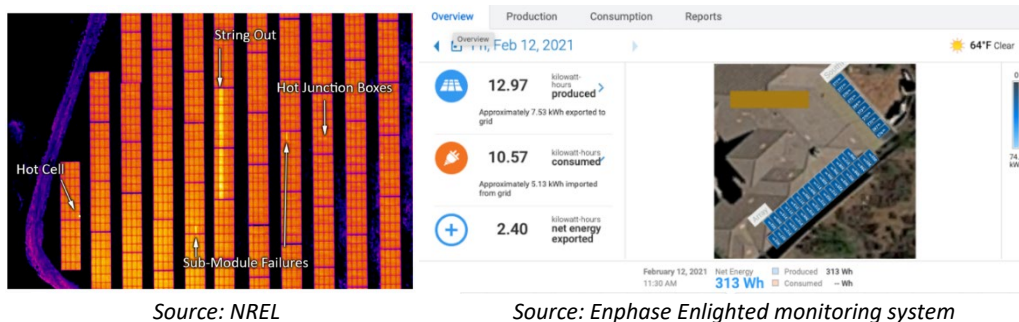

Source: NREL

Source: Enphase Enlighten monitoring system

Figure 7-1: Examples of remote PV system monitoring approaches.

Left—High-resolution, infrared aerial imaging can identify the location of failed strings, modules and cells, reducing the cost and risks of manual circuit testing. Image from Rob Andrews, Heliolytics Inc. Right—System monitoring dashboard from Enphase Enlighten monitoring system.

7.6 SYSTEM SECURITY

As discussed above, solar PV systems consist of complex components such as PV modules and inverters as well as electronic and internet-connected communications equipment related to net metering or other monitoring capabilities. Incorporating onsite security to protect this equipment is an important consideration. While some baseline security measures are likely to already be in place at landfill locations (such as fencing, security gates, security lights, etc.), some additional measures may be prudent when incorporating solar PV and associated equipment such as battery storage systems. Theft and vandalism occurring at solar farms are common insurance claims.

PV system installation on landfills will vary widely in size and location requiring security systems that are scaled to accommodate the specific system. Many landfills already incorporate security systems that may limit or control access. In many cases, the permanent fencing installed during the construction phase or associated with an existing landfill may be sufficient. However, more sophisticated security measures may be appropriate for remote or unsupervised facilities. These may include:⁴²

- Perimeter sensors associated with fencing such as motion sensors to secure against breaches of fences or unauthorized access.
- Access control systems to limit access to authorized personnel and track access to the PV system.
- Video surveillance allowing remote identification of activities on the site and potential threats to the PV system and enabling operators to take appropriate actions.
- Cyber security to monitor and protect against hackers and other cyber threats to the PV system and battery storage facilities.

⁴² See EERE's Solar Cybersecurity website at energy.gov/eere/solar/solar-cybersecurity for additional information.

8. A SUMMARY OF BEST PRACTICES FOR SITING SOLAR PV PROJECTS ON LANDFILLS

The best practices for siting solar PV projects on landfills discussed in this document are summarized in Table 8-1. This table provides an overview of best practices and is not an exhaustive list. Project stakeholders should consult experts in landfill and PV systems engineering and design when considering appropriate practices applicable to specific site conditions. PV technology is rapidly developing and changing.

Table 8-1: Summary of Technical Considerations, Challenges and Best Practices		
Technical Considerations	Challenges	Best Practices
Design		
Landfill slope and slope orientation	<ul style="list-style-type: none"> • Presence of steep slopes around landfill perimeter. • Slope orientation outside of optimal range for PV energy production. 	<ul style="list-style-type: none"> • Focus usable area on landfill top deck and buffer zones. • Consider special anchoring systems and other technologies for steeper slopes, accounting for slope stability. • Consider options for regrading to reorient slope, if compliant with 40 CFR §258.60 and allowed by local permitting authority.
Cap depth and components	<ul style="list-style-type: none"> • Restrictions on cap modifications in compliance with 40 CFR Part 258 Subpart F, permitted post-closure use and other federal, state, tribal and local laws. • Avoidance of cap penetrations and limited depth to barrier layer. • Compatibility with vegetative cover maintenance for erosion control. • Compatibility with stormwater management system. • Compatibility with subsurface gas and lateral drainage piping. 	<ul style="list-style-type: none"> • Work with local permitting authority to understand restrictions and options for modifying post closure use. • Use of lightweight anchoring systems that can be installed on landfill surface and do not penetrate the cap. • Use of vegetation that can accommodate shading and changes in rainfall patterns. • Strategic layout of PV arrays to accommodate stormwater management system.
Settlement potential	<ul style="list-style-type: none"> • Differential settlement effects on PV system structures and components. • Differential settlement effects on misalignment of arrays. 	<ul style="list-style-type: none"> • Strategic siting of PV arrays (i.e., use of older landfill areas and buffer zones where ongoing settlement is minimal). • Use of fixed tilt mounting systems. • Design of mounting and cabling systems to accommodate reasonable range of differential settlement.
Other landfill systems	<ul style="list-style-type: none"> • Compatibility with landfill gas, lateral drainage and leachate systems. • Compatibility with load bearing capacity of landfill gas and drainage piping. 	<ul style="list-style-type: none"> • Strategic layout of PV systems with setbacks from aboveground piping and facilities. • Avoid use of heavy equipment on landfill cover and other areas with subsurface piping. • Use lightweight PV systems and avoid differential settlement and stress on subsurface piping.

Table 8-1: Summary of Technical Considerations, Challenges and Best Practices		
Technical Considerations	Challenges	Best Practices
System weight and dynamic loading	<ul style="list-style-type: none"> • Limitations on system weight per cover-bearing capacity. • Local wind speed and snow load implications for array heights, tilt angles, structural supports and foundations. • Special considerations for landfill slope stability. 	<ul style="list-style-type: none"> • Match PV system design to weight-bearing capacity of landfill cover. • Establish optimal array heights and tilt angles that balance wind and snow load effects. • Consider snow accumulation potential when establishing array heights. • Conduct slope stability assessment and avoid dead weight and dynamic wind loads that could affect slope stability.
Lightning protection and grounding	<ul style="list-style-type: none"> • Limitations on areas available for grounding 	<ul style="list-style-type: none"> • Ground PV systems in soil in the buffer zone or, if allowed, the surface layer of the landfill cap. • Do not ground PV systems in waste material beneath landfill cap.
Cover management	<ul style="list-style-type: none"> • Compliance with landfill post-closure use plan. • Compatibility with vegetative cover maintenance. 	<ul style="list-style-type: none"> • Allow adequate distance between rows of PV arrays and adequate array height to provide access to mowing equipment. • Use vegetation strategies that can accommodate shading from PV panels and irregular rainfall patterns.
Stormwater management	<ul style="list-style-type: none"> • Compliance with NPDES and other stormwater management regulations. • Compatibility with stormwater management system. 	<ul style="list-style-type: none"> • Coordinate with state and local permitting officials. • Strategic layout of PV arrays to accommodate stormwater management system. • Redesign stormwater management system, as needed, to accommodate changes in rates and timing or stormwater runoff.
Integration with landfill gas monitoring and production systems	<ul style="list-style-type: none"> • Compatibility with landfill gas collection and energy production systems. • Coordination of landfill gas and PV solar energy production and transmission. 	<ul style="list-style-type: none"> • Strategic layout of PV systems with setbacks from landfill gas collection and production systems. • Explore opportunities to operate the landfill gas production and PV generating units as a hybrid system.
Site Security	<ul style="list-style-type: none"> • Prevent unauthorized access to PV system and associated safety hazards. • Protect against theft and vandalism. 	<ul style="list-style-type: none"> • Perimeter fencing. • Security cameras. • Security lighting with motion sensors.

Table 8-1: Summary of Technical Considerations, Challenges and Best Practices		
Technical Considerations	Challenges	Best Practices
Construction		
Site preparation and grading considerations	<ul style="list-style-type: none"> Restrictions on placing fill and/or regrading cap in compliance with 40 CFR Part 258 Subpart F and post-closure permit. Restrictions on operating heavy vehicles on landfill cover. Erosion control and cap protection during site preparation. 	<ul style="list-style-type: none"> Work with local permitting authority to understand restrictions and options for fill placement and grading on the landfill cap and obtain necessary approvals for modifications. Avoid use of heavy equipment for site preparation and grading on the landfill cap. Minimize grading requirements. Revegetate the landfill cover if any vegetation was removed in the grading process; explore opportunities for low maintenance vegetation using native species.
Penetrations of landfill cap	<ul style="list-style-type: none"> Restrictions on penetrations of landfill cap in compliance with 40 CFR Part 258 Subpart F, post-closure permit and other laws. Special engineering requirements for isolating cap penetrations when allowed. 	<ul style="list-style-type: none"> Work with local permitting authority to understand restrictions and options for penetrations and obtain necessary approvals for modifications. Use anchoring and mounting system designs and construction techniques that avoid cap penetration. Design isolation systems for areas surrounding any cap penetrations to prevent landfill gas migration to the surface.
Avoidance of landfill gas monitoring, piping and production equipment	<ul style="list-style-type: none"> Risk of inadvertent damage to landfill gas piping and production systems and associated hazards. 	<ul style="list-style-type: none"> Install temporary fencing around landfill gas piping and production systems to prevent damage by construction equipment. Ensure roads are set back from landfill gas piping and production systems and that vehicles stay on designated roads.
Dust control	<ul style="list-style-type: none"> Need to minimize dust generation during the construction process. 	<ul style="list-style-type: none"> Apply water to control dust during construction. Use smaller capacity water trucks that do not exceed the load bearing capacity of the landfill or place excessive live loads on buried gas and drainage piping.
Stormwater management	<ul style="list-style-type: none"> Compliance with NPDES stormwater management requirements for construction activities. Need to avoid excess erosion during construction. Need to avoid damage to stormwater management system during construction. 	<ul style="list-style-type: none"> Obtain NPDES permit prior to construction. Implement erosion control measures in disturbed areas of site. Minimize damage to the stormwater management system during construction; remediate any damage in compliance with NPDES permit and landfill post-closure care requirements.

Table 8-1: Summary of Technical Considerations, Challenges and Best Practices		
Technical Considerations	Challenges	Best Practices
Site security	<ul style="list-style-type: none"> • Prevent unauthorized access to construction site. • Protect against theft and vandalism. 	<ul style="list-style-type: none"> • Install permanent perimeter fencing prior to construction. • Consider use of temporary, lockable storage sheds to secure PV modules and BOS equipment. • Consider hiring security patrol service.
Operations & Maintenance		
Adherence with landfill post-closure operation, maintenance and monitoring plans	<ul style="list-style-type: none"> • Ensure compliance with landfill post-closure plans. 	<ul style="list-style-type: none"> • Consider combining landfill maintenance and PV system maintenance inspections to obtain operational and cost efficiencies. • Use PV system monitoring and analysis to identify potential settlement issues on the landfill.
Module washing and water management plan or natural cleansing	<ul style="list-style-type: none"> • Maintain module cleanliness to maximize PV system output. 	<ul style="list-style-type: none"> • Consider natural cleansing from storm events. • Avoid use of chemical cleansers in landfill applications. • If water cleansing is used and no on-site water is available, ensure that water trucks are not too heavy for the weight bearing capacity of the landfill.
Stormwater management	<ul style="list-style-type: none"> • Ensure long-term functionality of stormwater management systems. 	<ul style="list-style-type: none"> • Conduct routine maintenance of landfill cover and landfill cover materials. • Conduct preventive maintenance on stormwater management system (i.e., removal of sediment from swales and ponds, maintenance of mechanical equipment). • Conduct corrective maintenance (i.e., erosion and embankment repairs and mechanical equipment repairs).
Cover management	<ul style="list-style-type: none"> • Ensure long-term functionality of landfill cover and/or vegetative cover. 	<ul style="list-style-type: none"> • Conduct routine maintenance of landfill cover (i.e., grass mowing, weed control). • Conduct periodic inspections of landfill cover to identify cracks or fissures in the cover material, ponding, erosion or channeling from stormwater runoff, or occurrences of differential settlement. • Perform repairs to landfill cover as identified.
System monitoring and troubleshooting	<ul style="list-style-type: none"> • Ensure optimal performance of PV system. 	<ul style="list-style-type: none"> • Use remote monitoring system in conjunction with on-site weather station to identify system performance anomalies and to troubleshoot and isolate potential PV system problems.

APPENDIX A: SOLAR PV ON LANDFILL PROJECTS

Using publicly available information, RE-Powering America’s Land Initiative tracks renewable energy projects on formerly contaminated lands, landfills and mine sites to identify trends, educate stakeholders and encourage future site development. As noted in Figure A-1, solar PV on landfills has been a particularly attractive redevelopment option and, over time, has represented an increasing share of all RE-Powering sites. In 2012, only 39% of all RE-Powering sites were solar on landfill installations, whereas 2018 experienced a high of 81% of solar on landfill installations.

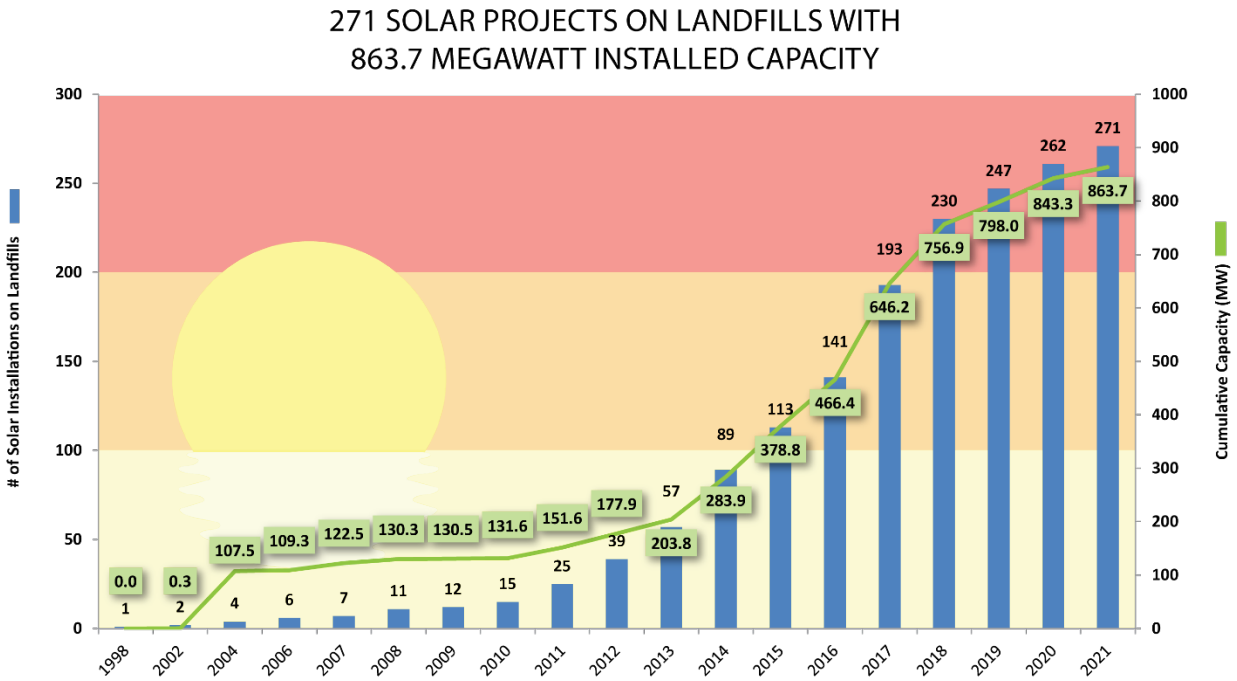

Source: EPA (2021c)

Figure A-1: Annual growth in solar installations on landfill/landfill buffer.

The RE-Powering Tracking Matrix is a list of completed projects where renewable energy systems have been installed on contaminated lands, landfills and mine sites maintained by the RE-Powering Initiative. The list is updated annually. This list is for informational purposes only. The information in this list was gathered from public announcements of renewable energy projects in the form of company press releases, news releases and, in some cases, conversations with the parties involved. This resource is for informational purposes only and may not be comprehensive of all projects completed on landfills. The following is an example of projects identified and the type of information included in the Tracking Matrix publication, more detail is provided in the Tracking Matrix publication (EPA 2021c). Please visit <https://www.epa.gov/re-powering/re-powering-tracking-matrix> to learn more about projects in your area or to download the list of projects

Table A-1: Selected Completed Solar Landfill Projects				
Site/Project Name	Location	Project Capacity (MW)	Completion Date	Project Type
Annapolis Renewable Energy Park	Annapolis, MD	16.8	2018	Wholesale Electricity
Belfast Landfill	Belfast, ME	0.122	2015	Wholesale Electricity
Brooklyn Landfill Solar	Brooklyn, OH	4	2018	Wholesale Electricity
Coyote Ridge Solar	Fort Collins, CO	1.95	2017	Community Owned / Subscription
Kenneth P. Ksionek Community Solar Farm at the Stanton Energy Center (SEC)	Orlando, FL	13	2017	Community Owned / Subscription
Rutland Landfill (Stafford Hill)	Rutland, VT	2.3	2015	Wholesale Electricity
Sky Park Solar	Eau Claire, WI	1	2017	Community Owned / Subscription
Tessman Road Municipal Solid Waste Landfill	San Antonio, TX	0.13	2009	Wholesale Electricity
Titcomb Solar Array	Amesbury, MA	4.5	2019	Wholesale Electricity
York County Landfill Solar	Hopewell Township, PA	0.3	2014	Onsite Use - Green Remediation

APPENDIX B: TOOLS AND RESOURCES

EPA'S RE-POWERING AMERICA'S LAND INITIATIVE, RENEWABLE ENERGY INTERACTIVE MAPPING TOOL

EPA's RE-Powering Mapper is an online interactive web application that allows users to visualize EPA's information about renewable energy potential on contaminated lands, landfills and mine sites. The application can be accessed at <https://www.epa.gov/re-powering/re-powering-mapper>.

Using screening criteria developed in collaboration with NREL, EPA has pre-screened well over 190,000 sites for their renewable energy potential. As part of this effort, EPA collaborated with state agencies from several EPA regions including California, Colorado, Connecticut, Florida, Hawaii, Illinois, Iowa, Maine, Maryland, Massachusetts, Minnesota, Missouri, New Jersey, New York, North Carolina, Oregon, Pennsylvania, Rhode Island, Texas, Virginia, West Virginia, Wisconsin and others.

This tool includes landfills from EPA's Landfill Methane Outreach Program (LMOP), EPA Superfund, RCRA Corrective Action and several state landfill programs.

Mapper features include:

- Screening results for multiple site types for solar, wind, biomass and geothermal energy.
- Search options by several attributes including state, acreage, renewable energy capacity, distance to nearest urban center and more.
- Site-specific screening reports.
- Links to EPA or state program managing the site clean-up.

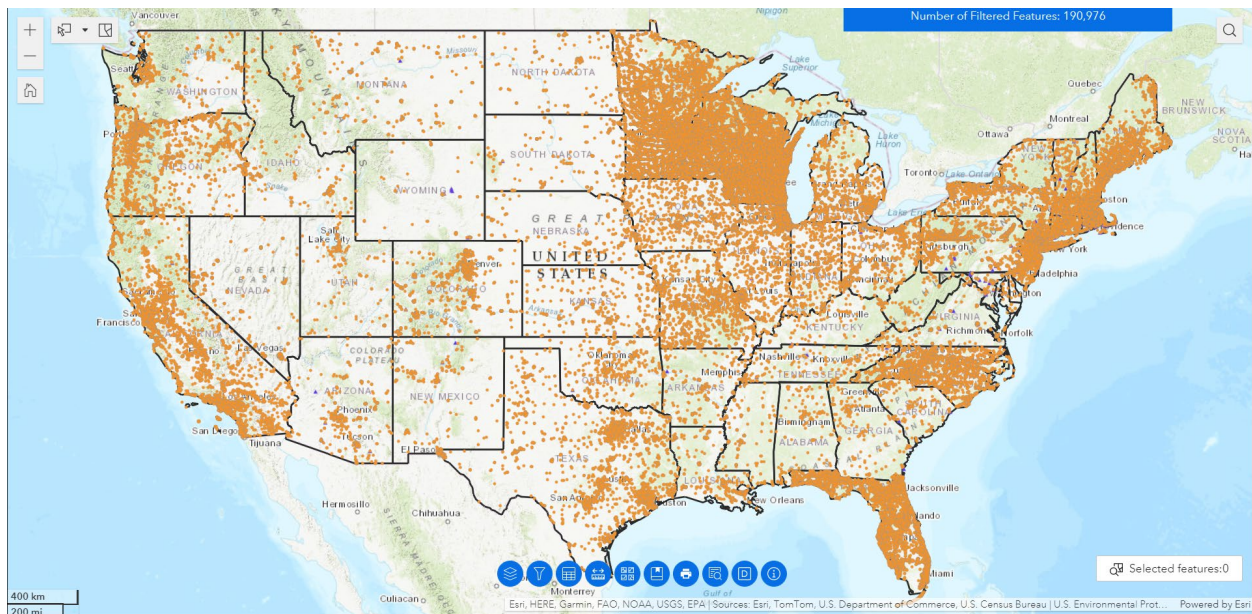

Figure B-1: RE-Powering Mapper application.

SITING RENEWABLE ENERGY ON CONTAMINATED PROPERTIES: ADDRESSING LIABILITY CONCERNS FACT SHEET

EPA has created *The Revitalization Handbook - Addressing Liability Concerns at Contaminated Properties* ("The Revitalization Handbook") in response to liability considerations (EPA 2020). It discusses initiatives and documents addressing the statutory protections under the Comprehensive Environmental Response, Compensation, and Liability Act (CERCLA, commonly known as Superfund) and potential liability concerns under RCRA.

The Revitalization Handbook summarizes federal statutory provisions and EPA cleanup enforcement documents that address potential liability concerns of parties involved in the cleanup and revitalization of contaminated sites. It is for use by parties involved in the assessment, cleanup and revitalization of sites, and provides a basic description of the tools that may be available to address liability concerns associated with different environmental statutes.

NREL SYSTEM ADVISOR MODEL

NREL System Advisor Model (SAM) is a performance and economic model to facilitate decision making for people involved in the renewable energy industry, ranging from project managers and engineers to incentive program designers, technology developers and researchers. The SAM application can be accessed at <https://sam.nrel.gov/>.

Energy systems that SAM models include: 1) PV systems, from small residential rooftop to large utility-scale systems; 2) battery storage with Lithium ion, lead acid or flow batteries for front-of-meter or behind-the-meter applications; 3) concentrating solar power systems for electric power generation, including parabolic trough, power tower and linear Fresnel; 4) industrial process heat from parabolic trough and linear Fresnel systems; 5) wind power, from individual turbines to large wind farms; 6) marine energy wave and tidal systems; 7) solar water heating; 8) fuel cells; 9) geothermal power generation; 10) biomass combustion for power generation; and 11) high concentration photovoltaic.

Types of projects that SAM performs economic calculations include:

- Residential and commercial projects where the renewable energy system is on the customer side of the electric utility meter (behind the meter), and power from the system is used to reduce the customer's electricity bill.
- PPA projects where the system is connected to the grid at an interconnection point, and the project earns revenue through power sales. The project may be owned and operated by a single owner or by a partnership involving a flip or leaseback arrangement.
- Third party ownership where the system is installed on the customer's (host) property and owned by a separate entity (developer), and the host is compensated for power generated by the system through either a PPA or lease agreement.

SAM consists of a performance model and financial model. The performance model calculates a system's energy output on an hourly basis (sub-hourly simulations are available for some technologies). The financial model calculates annual project cash flows over a period of years for a range of financing structures for residential, commercial and utility projects.

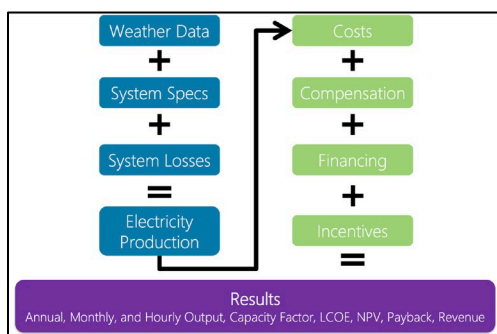

Source: NREL

Figure B-2: SAM block diagram

The SAM model calculates the cost of generating electricity based on information provided about a project's location, installation and operating costs, type of financing, applicable tax credits and incentives and system specifications. SAM also calculates the value of saved energy from a domestic solar water heating system and solar plus battery system. Figure B-3 shows the screenshot of a generic SAM interface.

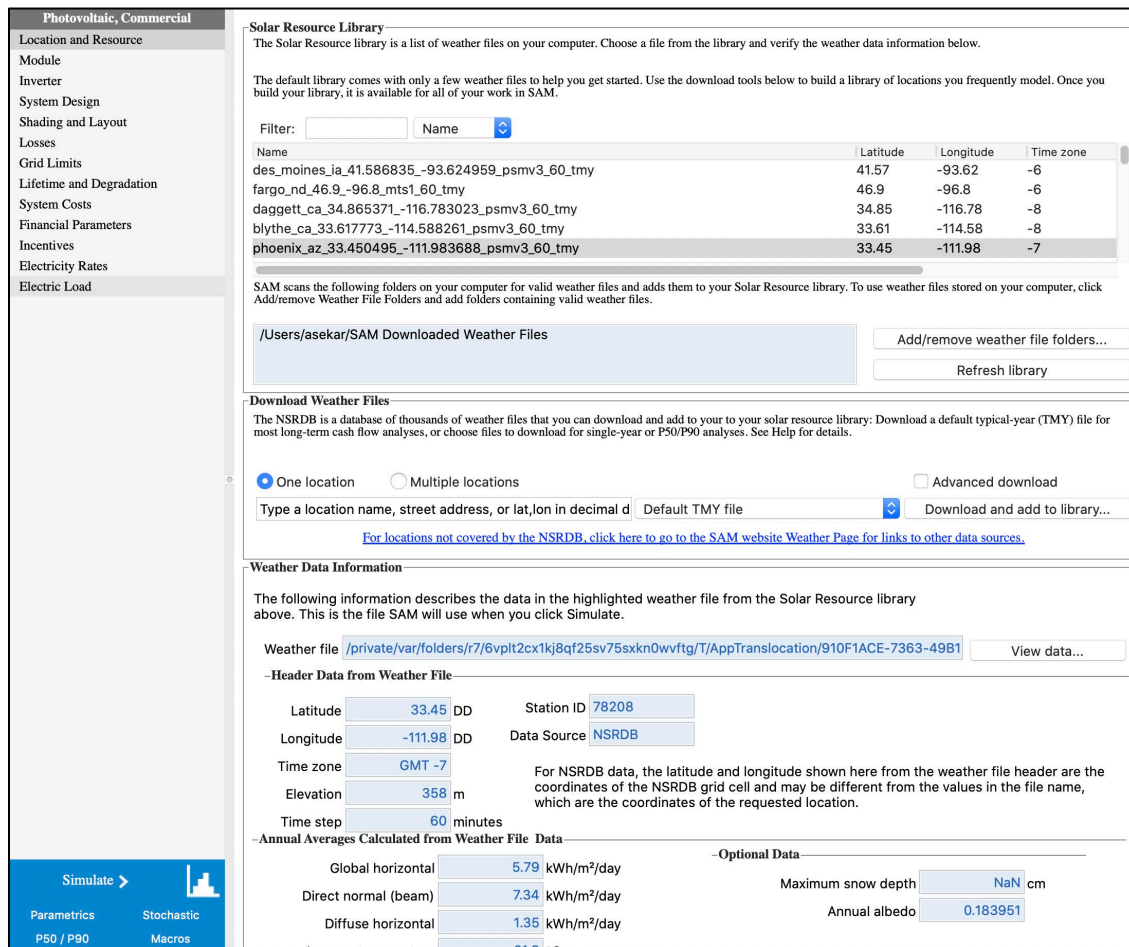

Source: NREL

Figure B-3: Generic SAM interface.

SAM is based on an hourly simulation engine that interacts with performance, cost and finance models to calculate energy output, energy costs and cash flows. The software can also account for the effect of incentives on project cash flows. SAM's spreadsheet interface allows for exchanging data with external models developed in Microsoft Excel. The model provides options for parametric studies, sensitivity analysis, optimization and statistical analyses to investigate impacts of variations and uncertainty in performance, cost and financial parameters on model results.

SAM models system performance using the TRNSYS building energy and system component simulation software developed at the University of Wisconsin combined with customized components (<http://sel.me.wisc.edu/trnsys/>). TRNSYS is a validated, time-series simulation program that can simulate the performance of PV, concentrating solar power, water heating systems and other renewable energy systems using hourly resource data. TRNSYS is integrated into SAM so there is no need to install TRNSYS software or be familiar with its use to run SAM. Figure B-4 shows the sample of simulation results. Visit the SAM website for more details and software download (<https://sam.nrel.gov/>).

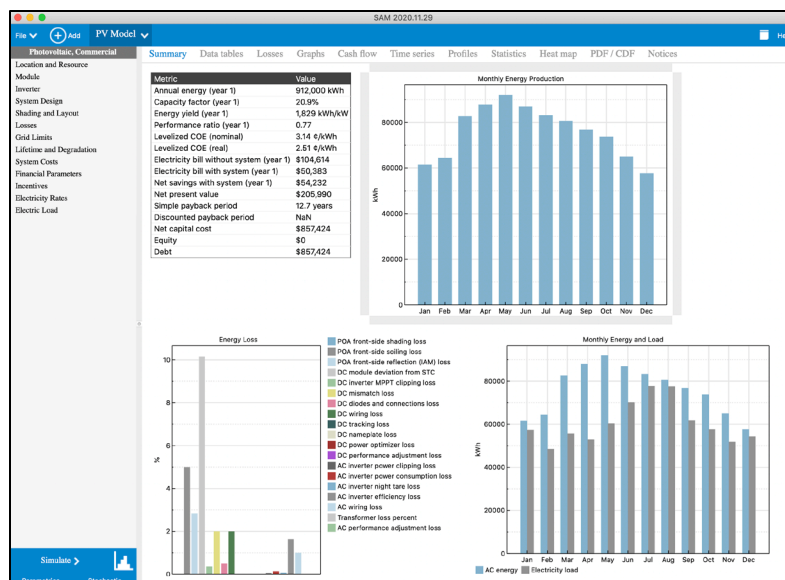

Source: NREL

Figure B-4: Sample output from SAM simulation.

NREL PVWATTS

NREL's PVWatts calculator determines the energy production and cost savings of grid-connected PV energy systems throughout the world. It allows homeowners, installers, manufacturers and researchers to easily develop estimates of the performance of hypothetical PV installations. The PVWatts application can be accessed at <https://pvwatts.nrel.gov/>.

PVWatts is the energy simulation engine used by DOE’s Solar Advisor Model. The PVWatts calculator provides users with a more basic user interface and provides only energy prediction information.

The PVWatts calculator works by creating hour-by-hour performance simulations that provide estimated monthly and annual energy production in kW and energy value. Users can select a location and choose to use default values or their own system parameters for size, electricity cost, array type and efficiency, tilt angle and azimuth angle. The azimuth angle is the compass bearing toward which the modules are pointed. A system facing true north has an azimuth of 0°, due east 90°, south 180° and west 270°. In addition, the PVWatts calculator can provide hourly performance data for the selected location.

PV systems should ideally be designed and installed with an azimuth within 45° of true south (for the northern hemisphere) to maximize electricity production. Modules typically produce the most energy if tilted at an angle equal to the latitude of the location, but system design economics may dictate a more cost-optimal orientation.

Using typical meteorological year weather data for the selected location, the PVWatts calculator determines hourly performance data for the system and adjusts it for losses—both in production of energy and the conversion from DC to AC power. Hourly values of AC energy are then summed to calculate monthly and annual AC energy production.

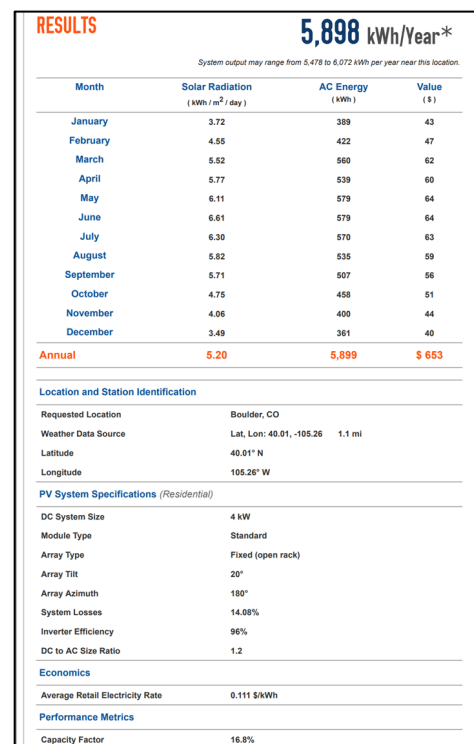

Source: NREL

Figure B-5: Example of input and output of PVWatts.

The PVWatts output is particularly useful in matching seasonal loads to output of the PV system. Running PVWatts with different scenarios is also helpful in understanding the variations in output from design changes to the system such as size, angle and orientation.

SOLAR DECISION TREE

The RE-Powering Electronic Decision Tree tool is a downloadable computer application that guides interested parties through a process to screen sites for their suitability for solar photovoltaics or wind installations. The RE-Powering Electronic Decision Tree tool can be accessed at <https://www.epa.gov/re-powering/re-powerings-electronic-decision-tree>.

Figure B-6: The Electronic Decision Tree uses a series of yes/no/skip questions.

This informational resource will help users identify whether potential barriers to a solar or wind project exist at a site of interest. The tool helps users:

- Explore potentially contaminated sites (e.g., brownfields, RCRA permitted, Superfund sites), landfills and underutilized sites and rooftops.
- Walk through a series of Yes / No / Skip questions supplemented by tips and links to relevant tools and information resources.
- Screen for site characteristics, redevelopment considerations, criteria specific to landfills and contaminated sites, energy load, policies and financial considerations.
- Generate reports of the screening results and user annotations that can be printed and/or copied into another document.

The tool comes with context-specific information regarding the various considerations that go into screening contaminated sites for renewable energy. An informative “companion guide” is accessed by clicking on “More Info” or “Strategies” buttons on specific pages within the tool and opens a window on your computer containing additional information on the topic and related resources. The decision tree tool is intended to engage non-experts in renewable energy to screen potentially contaminated or underutilized sites or landfills for whether they are good candidates for solar PV or wind projects. It is built so that more knowledgeable professionals can quickly navigate through the decision tree, and less experienced stakeholders can access additional information as they make their way through the questions. The tool is not intended to replace or substitute the need for a detailed site-specific assessment that would follow this kind of initial screening. Visit <https://www.epa.gov/re-powering/re-powerings-electronic-decision-tree> to learn more about the tool and download it.

More Info | Strategies

- 1. More Info: Overview
- 2. More Info: Site Characteristics
 - Information on Solar Resources
 - Limited Solar Resources
 - Usable Acreage
 - Limited Usable Acreage
 - Usable Rooftop Space
 - Limited Rooftop Space
 - Transmission Lines
 - Limited Access to Transmission Lines
- 3. More Info: Redevelopment Considerations
- 4. More Info: Contamination and Landfill Issues
- 5. More Info: Load Assessment and Financial

Site Characteristics

Information on Solar Resource

Sites tracked within EPA's [RE-Powering Mapper Tool](#) contain solar resource information. In addition, the U.S. Department of Energy's National Renewable Energy Laboratory (NREL) and its SunShot program provide resources to explore solar resource.

NREL's [Renewable Energy Resource maps](#) provide information at a regional level, while [PVWatts Viewer](#) provides resource information based on site address, zip code, or latitude and longitude. The EPA's [Renewable Energy Mapper](#) provides information on a site specific basis for a number of federal and state-tracked sites.

Also, see [SunShot's PVMapper Tool](#)

Limited Solar Resource

If the solar resource for a particular site is less than 3.5 kWh/m²/day, a solar PV system may not be ideal for redevelopment at this site, unless the state also has strong incentives.

Explore other renewable energy redevelopment options or infill redevelopment options. (Note: Infill indicates redevelopment within an urban setting.)

- NREL's [Renewable Energy Resource Maps](#)
- NREL's [PVWatts Viewer](#)
- EPA's [RE-Powering Mapper](#)
- EPA's publications on [smart growth, brownfields and infill development](#)

Usable Acreage

Usable acreage is typically characterized as "flat to gently sloping," southern exposures that are free from obstructions and get full sun for at least a 6-hour period each day. For example, eligible space for solar PV includes under-utilized or unoccupied land, vacant lots, and/or unused paved area (e.g. a parking lot or industrial site space).

If usable acreage for solar PV is expected to increase after the site is cleared for redevelopment (e.g., trash piles, decrepit structures, etc.), consider the land area to be cleared as part of your usable acreage estimate. Also, note that solar PV can be placed on a carport or other elevated structure above a parking lot or storage area, at added expense.

Usable acreage considerations include slope, shading and obstacles:

Slope

For land areas that are unpaved, check that the slope is less than 6 degrees (~10% grade) or else can be easily graded at a reasonable cost. If not, solar PV on these areas may not be viable unless solar geomembrane technologies and/or alternative mounting systems, which can be used on steeper grades, are considered.

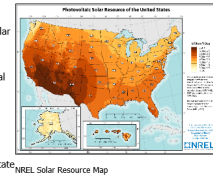

Figure B-7: Supplemental information screen.

HYDROLOGIC EVALUATION OF LANDFILL PERFORMANCE (HELP) MODEL

The Hydrologic Evaluation of Landfill Performance (HELP) Model can assist in evaluating stormwater runoff at landfills. It is a quasi-two-dimensional hydrologic model of water movement across, into, through and out of landfills. It estimates water balances for landfills and other land disposal systems. The program models rainfall, runoff, infiltration and other water pathways to estimate how much water builds up above each landfill liner.

HELP Model

Hydrologic Evaluation of Landfill Performance Model

Import v3.07 Files

Reset All

Review

Run HELP Model

General Information

Edit Reset

Title:

Address:

Nashville

TN

Coordinates (degrees) Lat: Long:

Years of Simulation: Units:

LF Area (acres): Specify Initial Moisture?:

% Subject to Runoff: Water/snow storage (in):

Weather

Reset

Data Method	Parameter	Years of Data		
Simulate Weather	Precipitation	30	✓	↗
	Temperature	30	✓	↗
	Solar Radiation	30	✓	↗
Enter or Import	Wind Speed/Rel Humidity		✓	↗
	Other Parameters <small>(growing season, LAI & evap zone)</small>		✓	↗

Runoff Curve Number

Edit Reset

HELP-computed curve number (3):

HELP will use the curve number:

Soil & Design

Add/Insert New Layers Reset

Temporarily suspend layer rule checking

1	SIL - Silty Loam	↗ ↕ 🗑
2	CoS - Coarse Sand	↗ ↕ 🗑
3	LDPE Membrane	↗ ↕ 🗑
4	SIC - Silty Clay (Moderate)	↗ ↕ 🗑
5	Municipal Solid Waste (MSW) (900 pcy)	↗ ↕ 🗑
6	LFS Loamy Fine Sand	↗ ↕ 🗑
7	Drainage Net (0.5 cm)	↗ ↕ 🗑
8	HDPE Membrane	↗ ↕ 🗑
9	G - Gravel	↗ ↕ 🗑
10	HDPE Membrane	↗ ↕ 🗑
11	Liner Soil (High)	↗ ↕ 🗑

Figure B-8: HELP model screen.

The model applies to open, partially closed and fully closed sites. Landfill systems can be modeled that include various combinations of:

- Vegetation.
- Cover soils.
- Waste cells.
- Lateral drain layers.
- Low permeability barrier soils.
- Synthetic geomembrane liners.

The model calculates daily, monthly, annual and average annual estimates. It estimates amounts of:

- Runoff.
- Evapotranspiration.
- Drainage.
- Leachate collection.
- Liner leakage.

Read more and download the HELP Model here: <https://www.epa.gov/land-research/hydrologic-evaluation-landfill-performance-help-model>.

APPENDIX C: FINANCING AND PROCUREMENT OPTIONS

OWNER AND OPERATOR FINANCING (DIRECT OWNERSHIP)

The owner/operator financing structure is characterized by a single entity with the financial strength to fund all the solar project costs and, if a private entity, sufficient tax appetite to utilize all of the project's tax benefits. Private owners/operators typically establish a special purpose entity (SPE) that solely owns the assets of the project. An initial equity investment into the SPE is funded by the private entity using existing funds and all the project's cash flows and tax benefits are utilized by the entity. This equity investment is typically matched with debt financing for the majority of the project costs. Project debt is typically issued as a loan based on the owner/operators' assets and equity in the project. In addition, private entities can utilize any of federal tax credits offered.

For public entities that choose to finance, own and operate a solar project, funding can be raised as part of a larger, general obligation bond, as a stand-alone tax credit bond, through a tax-exempt lease structure, bank financing, grant and incentive programs, internal cash or some combination of the above. Certain structures are more common than others and grant programs for solar programs are on the decline. Regardless, as tax-exempt entities, public entities are unable to benefit directly from the various tax credit-based incentives available to private companies. This has given way to the now common use of third-party financing structures such as the PPA described below.

THIRD PARTY DEVELOPERS WITH PPAS

As an alternative to owner/operator financing, the site host (owner/operator) can turn to third party developers to develop a solar project. In exchange for access to a site through a lease or easement arrangement, third-party developers will finance, develop, own and operate solar projects using their own expertise and sources of tax equity financing and debt capital. Once the system is installed, the third-party developer will sell the electricity to the site host or local utility via a PPA, a contract to sell electricity at a negotiated rate over a fixed period of time. The PPA typically will be between the third-party developer and the site host if it is a "behind the meter" retail transaction or directly with an electric utility if it is a wholesale transaction.

Site hosts benefit by either receiving competitively priced electricity from the project via the PPA or land lease revenues for making the site available to the solar developer via a lease payment. This lease payment can take on the form of either a revenue-sharing agreement or an annual lease payment. In addition, third-party developers can utilize federal tax credits. For public entities, this arrangement allows them to use the benefits of the tax credits (low PPA price, higher lease payment) while not directly receiving them. The term of a PPA typically varies from 20-25 years.

THIRD PARTY "FLIP" AGREEMENTS

The most common use of this model is a site host working with a third-party developer who then partners with a tax-motivated investor in a special purpose entity that would own and operate the project. Initially, most of the equity provided to the SPE would come from the tax investor and most of the benefit would flow to the tax investor (as much as 99 percent). When the tax investor has fully monetized the tax benefits and achieved an agreed upon rate of return, the allocation of benefits and majority ownership (95 percent) would "flip" to the site host (but not within the first five years). After the flip, the site host would have the option to buy out all or most of the tax investor's interest in the project at the fair market value of the tax investor's remaining interest.

A "flip" agreement can also be signed between a developer and investors within an SPE, where the investor would begin with the majority ownership. Eventually, the ownership would flip to the developer once the investor's return is met.

HYBRID FINANCIAL STRUCTURES

As the solar market evolves, hybrid financial solutions have been developed in certain instances to finance solar projects. A particular structure nicknamed “The Morris Model” after Morris County, New Jersey, combines highly rated public debt, a capital lease and a PPA. Low-interest public debt replaces more costly financing available to the solar developer and contributes to a very attractive PPA price for the site hosts. New Markets Tax Credits have been combined with PPAs and public debt in other locations, such as Denver and Salt Lake City.

SOLAR SERVICES AGREEMENT AND OPERATING LEASE

The Solar Services Agreement (SSA) and Operating Lease business models have been predominately used in the municipal and cooperative utility markets due its treatment of tax benefits and the rules limiting federal tax benefit transfers from non-profit to for-profit companies. Under IRS guidelines, municipalities cannot enter capital leases with for-profit entities when the for-profit entities capture tax incentives. As a result, several business models have emerged as a work around to this issue. SSA is one such model wherein a private party sells “solar services” (i.e., energy and RECs) to a municipality over a specified contract period (typically long enough for the private party to accrue the tax credits). The non-profit utility typically purchases the solar services with either a one-time up-front payment equal to the turn-key system cost minus the federal tax credit or may purchase the services in annual installments. The municipality may buyout the system once the third-party has accrued the tax credits, but due to IRS regulations, the buyout of the plant cannot be included as part of the SSA (i.e., the SSA cannot be used as a vehicle for a sale and must be a separate transaction).

Similar to the SSA, there are a variety of lease options that are available to municipalities that allow the capture of tax benefits by 3rd party owners, which result in a lower cost to the municipality. These include an operating lease for solar services (as opposed to an equipment capital lease) and a complex business model called a “sales/lease-back”. Under the sales/lease-back model, the municipality develops the project and sells it to a 3rd party tax equity investor who then leases the project back to the municipality under an operating lease. At the end of the lease period and after the tax benefits have been absorbed by the tax equity investor, the municipality may purchase the solar project at fair market value.

SALE/LEASE BACK

In this widely accepted model, the public or private entity would install the PV system, sell it to a tax investor and then lease it back. As the lessee, they would be responsible for operating and maintaining the solar system as well as have the right to sell or use the power. In exchange for use of the solar system, the public or private entity would make lease payments to the tax investor (the lessor). The tax investor would have rights to federal tax benefits generated by the project and the lease payments. Sometimes, the entity is allowed to buy back the project at 100 percent fair market value after the tax benefits are exhausted.

COMMUNITY SOLAR

The concept of “Community Solar” is one in which the costs and benefits of one large solar project are shared by several participants. A site owner may be able to make the land available for a large solar project, which can be the basis for a community solar project. Ownership structures for these projects vary but the large projects are typically owned or sponsored by a local utility. Community Solar Gardens are distributed solar projects wherein utility customers have a stake via a pro-rated share of the project’s energy output. This business model is targeted to meet demand for solar projects by customers who rent/lease homes or businesses, do not have good solar access at their site, or do not want to install solar system on their facilities. Customer pro-rated shares of solar projects are acquired through a long-term transferrable lease of one or more modules, or they subscribe to a share of the project in terms of a specific level of energy output or the energy output of a set amount of capacity. Under the customer lease option, the customer receives a billing credit for the number of kWh their pro-rated share of the solar project produces each month; it is also known as “virtual net-metering.” Under the customer subscription option, the customers typically pay a set price for a block of solar energy (i.e., 100 kWh per month blocks) from the community solar project. Other models include monthly energy outputs from a specific investment dollar amount or a specific number of modules.

Community solar garden and customer subscription-based projects can be solely owned by the utility, owned solely by third-party developers with facilitation of billing provided by the utility, or may be a joint venture between the utility and a third-party developer leading to eventual ownership by the utility after the tax benefits have been absorbed by the third-party developer.

Community solar projects are located across the country including 39 states and Washington D.C. As of 2020, 39 states and Washington D.C. offered solar incentives for community solar.⁴³ Community Solar is sometimes known as “Community Gardens” depending on the location (e.g., Colorado).

⁴³ For up-to-date information on community solar, visit [nrel.gov/state-local-tribal/community-solar.html](https://www.nrel.gov/state-local-tribal/community-solar.html).

APPENDIX D: REFERENCES

- American Society of Civil Engineers (ASCE) (2006). Standard Guidelines for the Installation of Urban Stormwater Systems. ASCE Standard No. 46-05.
- American Society of Civil Engineers (ASCE) and the Water Environment Federation (WEF) (1992). Design and Construction of Urban Stormwater Management Systems. ASCE MOP No. 77, WEF MOP FD-20.
- Beatty, B., J. Macknick, J. Mccall, G. Braus, and D. Buckner (2017). Native Vegetation Performance Under a Solar PV Array at the National Wind Technology Center. NREL/TP-1900-66218. National Renewable Energy Laboratory.
- Burgess, C., and J. Goodman (2018). Solar Under Storm, Select Best Practices for Resilient Ground-Mount PV Systems with Hurricane Exposure. Rocky Mountain Institute. Retrieved March 16, 2022, from https://rmi.org/wp-content/uploads/2018/06/Islands_SolarUnderStorm_Report_digitalJune122018.pdf.
- Denholm, P., J. Eichman, and R. Margolis (2017). Evaluating the Technical and Economic Performance of PV Plus Storage Power Plants. NREL/TP-6A20-68737. National Renewable Energy Laboratory.
- El-Fadel, M., and R. Khoury (2000). Modeling Settlement in MSW Landfills: a Critical Review. *Critical Reviews in Environmental Science and Technology*, 30(3), 327-361.
- Elsworth, J., and O. Van Geet (2020). Solar Photovoltaics in Severe Weather: Cost Considerations for Storm Hardening PV Systems for Resilience. NREL/TP-7A40-75804. National Renewable Energy Laboratory.
- Feldman, D., V. Ramasamy, R. Fu, A. Ramdas, J. Desai, and R. Margolis (2021). U.S. Solar Photovoltaic System Cost Benchmark: Q1 2020. NREL/TP-6A20-77324. National Renewable Energy Laboratory.
- Fu, R., T. Remo, and R. Margolis (2018). 2018 U.S. Utility-Scale Photovoltaics-Plus-Energy Storage System Costs Benchmark. NREL/TP-6A20-71714. National Renewable Energy Laboratory.
- Green, M. A., E.D. Dunlop, J. Hohl-Ebinger, M. Yoshita, N. Kopidakis, and A.W. Ho-Baillie (2020). Solar cell efficiency tables (Version 55). *Progress in Photovoltaics: Research and Applications*, 28(1), 3-15.
- Haggerty, S., and S. Stockwell (2019). Renewable Energy and Wildlife in Maine. Maine Audubon. Retrieved March 15, 2022 at https://maineaudubon.org/wp-content/uploads/2019/11/MaineAudubonRenewables_Wildlife2019Report.pdf.
- HDR (2022). Hickory Ridge Landfill. Retrieved March 16, 2022 from <https://www.hdrinc.com/portfolio/hickory-ridge-landfill>.
- Heath, G. A., T. J. Silverman, M. Kempe, et al. (2020). Research and development priorities for silicon photovoltaic module recycling to support a circular economy. *Nature Energy*, 5(7), 502-510.
- Herrera, T. (2009). Solar Power Landfill Cover Goes Live in Texas. GreenBiz. Retrieved March 16, 2022 from <https://www.greenbiz.com/article/solar-power-landfill-cover-goes-live-texas>.
- Hersch, R. (2011). Amherst, Massachusetts: Impediments to Solar Installations on Closed Landfills. Center for Public Environmental Oversight. Retrieved March 16, 2022 from <http://www.cpeo.org/pubs/AmherstSolar.pdf>.
- Jordan, D. C., and S. R. Kurtz (2013). Photovoltaic degradation rates—an analytical review. *Progress in photovoltaics: Research and Applications*, 21(1): 12-29.
- Livingston, E.H., E. Shaver, and J.J. Skupien (1997). Operation, Maintenance, and Management of Stormwater Management Systems. Retrieved March 16, 2022, from <https://stormwater.ucf.edu/wp-content/uploads/2014/09/stormwaterOMM.pdf>.
- Maine Audubon et al. (2019). Best Practices for Low Impact Solar Siting, Design, and Maintenance. Retrieved March 15, 2022 at <https://maineaudubon.org/wp-content/uploads/2020/09/Best-Practices-Nov-2019-singl-pgsLR.pdf>.

- McLaren, J. (2014). Advanced Inverter Functions to Support High Levels of Distributed Solar. NREL/BR-6A20-62612. National Renewable Energy Laboratory.
- Mitchell, M., and N. Kovacs (2011). Hartford Solar Landfill Project. Connecticut Coalition for Environmental Justice. Retrieved March 16, 2022, from <http://www.cpeo.org/pubs/HartfordSolar.pdf>.
- Mongird, K., V. Viswanathan, J. Alam, C. Vartanian, V. Sprenkle, and R. Baxter (2020). 2020 Grid Energy Storage Technology Cost and Performance Assessment. DOE/PA-0204. U.S. Department of Energy.
- Ong, S., C. Campbell, P. Denholm, R. Margolis, and G. Heath (2013). Land-Use Requirements for Solar Power Plants in the United States. NREL/TP-6A20-56290. National Renewable Energy Laboratory.
- Palmintier, B., R. Broderick, B. Mather, et al. (2016). On the Path to SunShot: Emerging Issues and Challenges in Integrating Solar with the Distribution System. NREL/TP-5D00-65331. National Renewable Energy Laboratory.
- Sengupta, M., Y. Xie, A. Lopez, A. Habte, G. Maclaurin, and J. Shelby (2018). The National Solar Radiation Data Base (NSRDB). *Renewable and Sustainable Energy Reviews*, 89 (June): 51-60.
- SMA Solar Technology (2017). Sunny Portal Registration for Sunny Boy US With Webconnect: Customizing the Sunny Portal Plant. Retrieved March 14, 2020, from <https://www.sma-sunny.com/us/sunny-portal-registration-for-sunny-boy-us-with-webconnect-customizing-the-sunny-portal-plant/>.
- Solar Power World (2018). Avoiding the costly consequences of frost heave on solar ground-mounts. Retrieved March 16, 2022, from <https://www.solarpowerworldonline.com/2018/03/avoiding-costly-consequences-frost-heave-solar-ground-mounts/>.
- Solar Power World (2019). How does solar on capped landfills work? Retrieved March 14, 2022, from <https://www.solarpowerworldonline.com/2019/07/how-does-solar-on-capped-landfills-work/>.
- Soltage (2021). Soltage Announces First Landfill Community Solar Project in New Jersey. Retrieved March 14, 2022, from https://soltage.com/wp-content/uploads/tricounty_community_solar_soltage_release_may_2021_ant.docx.pdf.
- U.S. Conference of Mayors (2018). Cities with city-wide renewable energy goals (including commercial and residential). Retrieved March 14, 2020, from <https://www.usmayors.org/programs/alliance-for-a-sustainable-future/>.
- U.S. Department of Energy (DOE) (2015). Photovoltaic Systems with Module-Level Power Electronics. DOE/GO-102015-4755. Office of Energy Efficiency & Renewable Energy.
- U.S. Department of Energy (DOE) (2018). Solar Photovoltaic Systems in Hurricanes and Other Severe Weather. DOE/GO-102018-5109. Office of Energy Efficiency & Renewable Energy.
- U.S. Environmental Protection Agency (EPA) (1988). Report to Congress, Solid Waste Disposal in the United States, Part II. EPA-530-SW-88-011B. Office of Solid Waste and Emergency Response.
- U.S. Environmental Protection Agency (EPA) (1993). Engineering Bulletin, Landfill Covers. EPA-540-S-93-500. Office of Emergency and Remedial Response and Office of Research and Development.
- U.S. Environmental Protection Agency (EPA) (2002). 25 Years of RCRA: Building on Our Past to Protect Our Future. EPA-K-02-027. Office of Solid Waste and Emergency Response.
- U.S. Environmental Protection Agency (EPA) (2004). (Draft) Technical Guidance for RCRA/CERCLA Final Covers. EPA-540-R-04-007. Office of Solid Waste and Emergency Response.
- U.S. Environmental Protection Agency (EPA) (2005). Guidance for Evaluating Landfill Gas Emissions from Closed or Abandoned Facilities. EPA-600-R-05-123a. Office of Research and Development.
- U.S. Environmental Protection Agency (EPA) (2006). Revegetating Landfills and Waste Containment Areas Fact Sheet. EPA-542-F-06-001. Office of Superfund Remediation and Technology Innovation.

- U.S. Environmental Protection Agency (EPA) (2009). Building Vibrant Communities: Community Benefits of Land Revitalization. EPA-560-F-09-517. Office of Solid Waste and Emergency Response.
- U.S. Environmental Protection Agency (EPA) (2014). Resource Conservation and Recovery Act Orientation Manual 2014. EPA-530-F-11-003. Office of Solid Waste and Emergency Response.
- U.S. Environmental Protection Agency (EPA) (2019). RE-Powering America's Land Initiative, Interconnection, Plugging RE-Powering Sites into the Electric Grid. Retrieved March 14, 2022, from https://www.epa.gov/sites/default/files/2019-10/documents/interconnection_plugging_re_powering_sites_into_the_electric_grid_oct2019_508.pdf.
- U.S. Environmental Protection Agency (EPA) (2020). The Revitalization Handbook, Addressing Liability Concerns at Contaminated Properties. EPA-325-B-20-001. Office of Site Remediation Enforcement.
- U.S. Environmental Protection Agency (EPA) (2021a). EPA Announces Plans to Use First \$1B from Bipartisan Infrastructure Law Funds to Clear Out the Superfund Backlog. Retrieved March 15, 2022 from <https://www.epa.gov/newsreleases/epa-announces-plans-use-first-1b-bipartisan-infrastructure-law-funds-clear-out>.
- U.S. Environmental Protection Agency (EPA) (2021b). Municipal Solid Waste Landfills. Retrieved March 14, 2022, from <https://www.epa.gov/landfills/municipal-solid-waste-landfills>.
- U.S. Environmental Protection Agency (EPA) (2021c). Re-Powering America's Land Initiative, Project Tracking Matrix. Retrieved March 14, 2022, from https://www.epa.gov/system/files/documents/2021-11/re_on_cl_tracking_matrix_110321_508.pdf.
- U.S. Environmental Protection Agency (EPA) (2022a). RE-Powering America's Land Initiative, Benefits Matrix. Retrieved April 20, 2022, from <https://www.epa.gov/re-powering/re-powering-benefits-matrix>.
- U.S. Environmental Protection Agency (EPA) (2022b). RE-Powering America's Land Initiative, Mapper User Guide and Data Documentation. Retrieved April 26, 2022, from <https://www.epa.gov/re-powering/mapper-technical-documents>.
- U.S. Environmental Protection Agency (EPA) (2022c). RE-Powering America's Land Initiative, Mapper Factsheet. Retrieved April 26, 2022, from <https://www.epa.gov/re-powering/mapper-technical-documents>.
- Walker, A., E. Lockhart, J. Desai, et al. (2020). Model of Operation-and Maintenance Costs for Photovoltaic Systems. NREL/TP-5C00-74840. National Renewable Energy Laboratory.
- Zinaman, O., A. Aznar, C. Linvill, N. Darghouth, T. Dubbeling, and E. Bianco (2017). Grid-connected distributed generation: compensation mechanism basics. NREL/BR-6A20-68469. National Renewable Energy Laboratory.



 **EPA**
United States
Environmental Protection
Agency